



AMERICAN TOOTH INDUSTRIES

2024 Catalog Issue



OrthoMart

QUALITY ORTHODONTIC SUPPLIES

VOL 6 #1

First Rapid Palatal Expander Designed in the US, for the US Market



Price as low as \$9.59

Orthodontics since 1971



OFFERS EXPIRE 12/31/24
NOT VALID WITH ANY OTHER OFFERS
Visit: www.pozziorthodontics.com
Buy online: americantooth.com/store

CALL TODAY TO PLACE YOUR ORDER
805-487-9868
1200 Stellar Drive
Oxnard, California 93033-2404

Pozzi Orthodontics Expanders



POZZI® HYRAX EXPANDER

The Pozzi Hyrax Expander has been designed for the US market. Made entirely of biomedical stainless steel, completely smooth and polished with no rough areas for maximum hygiene. Expander limit and directional arrow are laser etched into the surface of the expander body. Supplied with a BP Palatal Expander Key. Packs of 1



202-C74-KEY10
Palatal Expander Key - Fluorescent Green - 10 Pack, Price \$14.38



CODE	↔ ↻				activation turns for maximum expansion limit	PRICE
	arms mm	body mm	mm	mm		
 202-C71-09	1,5	14	9	0,8	40	\$13.18
 202-C71-11	1,5	16	11	0,8	50	\$13.18
 202-C71-13	1,5	18	13	0,8	60	\$13.18

SPECIAL:
BUY 200*
GET 75
FREE!

SPECIAL:
BUY 70*
GET 25
FREE!

SPECIAL:
BUY 10*
GET 3
FREE!

POZZI® HYRAX EXPANDER - NO ARM



The Pozzi® Hyrax Expander - No Arm is the next product from the popular Hyrax line. Pozzi® Hyrax Expander - No Arm has special grooves to accommodate the appliance to ensure an optimal laser welding process. Expansion capacity in mm, directional arrow are laser marked on the body of the screw. Pack of 1. Comes with a Palatal Expander Key.



202-C74-KEY10
Palatal Expander Key - Fluorescent Green - 10 Pack, Price \$14.38



This also includes a .Stl file to access digitally manufactured RPEs. Please go to <https://www.pozziorthodontics.com/expanders> to download the file.

CODE	↔ ↻		activation turns for maximum expansion limit	PRICE
	body mm	mm		
 202-C71-09N	9 mm	14	9	\$10.08
 202-C71-11N	11mm	16	11	\$10.08
 202-C71-13N	13mm	18	13	\$10.08

SPECIAL:
BUY 10*
GET 3
FREE!

SPECIAL:
BUY 70*
GET 25
FREE!

SPECIAL:
BUY 200*
GET 75
FREE!

Pozzi Orthodontics Expanders

POZZI® MICRO-EXPANDER

The Pozzi Micro-Expander are available in 8mm and 12mm sizes. Featuring a slim design unmatched by other rapid expanders. These unique devices have 2 extra-long arms, allowing for the possibility of anterior support and ensuring excellent stability and maximum comfort in any configuration. The expander can be placed in the standard position, with a laser-marked arrow and max-expansion length visible to the user, or in the upside-down position, indicated by laser-marked arrows, to reduce the space occupied by the expander arms if the jaw is especially narrow. The Pozzi Micro-Expander can also be used to obtain dental expansion in the lower jaw. Supplied with a BP Palatal Expander Key.

Packs of 1



SPECIAL:
BUY 10*
GET 3
FREE!

SPECIAL:
BUY 70*
GET 25
FREE!

SPECIAL:
BUY 200*
GET 75
FREE!

- It can be positioned in the standard way, i.e. with the markings of the arrow and maximum expansion visible
- It can also be positioned upside down in case of very narrow palates, to minimize the bulkiness of the arms once they are bent.



	CODE	↔		activation turns for maximum expansion limit	PRICE
		body mm	mm		
	202-C73-08	12	8	35	\$24.68
	202-C73-12	16	12	50	\$24.68

POZZI® EXPANDER FOR LOWER ARCH



The Pozzi Expander for Lower Arch for Lower Arch is a specialized design to accommodate the needs of the orthodontic specialists. These Expanders may be fabricated on the lingual surface of either of the maxillary of the mandibular arch for expansion on distalization. The overall width has been reduced resulting in an improved fit, allowing for a more comfortable appliance in the patient's mouth. Supplied with a BP Palatal Expander Key.

Packs of 1

SPECIAL:
BUY 10*
GET 3
FREE!

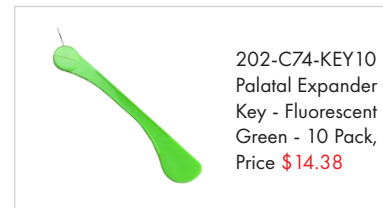
SPECIAL:
BUY 4*
GET 1
FREE!



	CODE	↔		activation turns for maximum expansion limit	PRICE
		body mm	mm		
	202-9000-08	12	8	35	\$20.80
	202-9000-11	16	11	50	\$20.80

Pozzi Orthodontics Expanders



POZZI® RAPID TELESCOPIC EXPANDER

The Pozzi Rapid Telescopic Expander guides create constant friction during the expansion movement. This expander is ideal for very narrow palates. The expanders with 9mm, 11mm and 13mm sizes feature a compact design for ease of arm bending and reducing the overall dimensions of the device. Supplied with a BP Palatal Expander Key. Packs of 1



SPECIAL:
BUY 10*
GET 3
FREE!

SPECIAL:
BUY 4*
GET 1
FREE!

	CODE	∅		↔		↻		activation turns for maximum expansion limit	PRICE
		arms mm	body mm	mm	mm	mm	mm		
	202-408-102	1,5	14	9	0,8	40	\$25.80		
	202-408-103	1,5	16	11	0,8	50	\$25.80		
	202-408-104	1,5	18	13	0,8	60	\$25.80		

POZZI® EXPANDER WITH ORTHOGONAL ARMS

The Pozzi Expander with Orthogonal Arms is used to obtain distal, mesial, and sagittal expansion movement in the treatment of Class II and Class malocclusions. It is an ideal solution for patients needing orthopaedic maxillary expansion. Supplied with a BP Palatal Expander Key.



- Available in two expansion capacities for every therapeutic need.
- High stability, comfort, and safety.
- Optimal positioning using orthogonal position of bending arms, reduces the device size.
- Palatal Expander Key included, allows easy intraoral activation by the patient.
- Micro-machined guide pins providing mechanical friction throughout treatment.
- End-stop limits the possibility of over-treatment.

SPECIAL:
BUY 200*
GET 75
FREE!

SPECIAL:
BUY 70*
GET 25
FREE!

SPECIAL:
BUY 10*
GET 3
FREE!

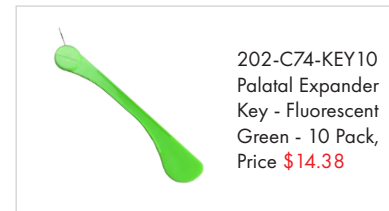

	CODE	∅		↔		↻		activation turns for maximum expansion limit	PRICE
		arms mm	body mm	mm	mm	mm	mm		
	202-9000-009	1,5	14	9	0,8	40	\$20.80		
	202-9000-011	1,5	16	11	0,8	50	\$20.80		

Leonardo Rapid Palatal Expander

LEONARDO is a rapid palatal expander with innovative features for safer, easier, and more effective use. The telescopic guides of the expander's body remain overlapped - even at its maximum opening - to ensure rigidity, stability, and expansion precision. The arms are laser welded to maximize the resistance to torsion and compression and prevent breakage. The arm's housing is designed with no cavities or blind parts, guaranteeing maximum hygiene. The mechanical locking and anti-return system prevent unintentional disassembly. International patents protect the Leonardo rapid expander.

**SPECIAL
Introductory
Prices**



GROUP/ITEM #	DESCRIPTION	
201-V30-0812 E	Leonardo Rapid Palatal Expander 8mm	\$51.90
201-V30-1014 E	Leonardo Rapid Palatal Expander 10mm	\$51.90
201-V30-1216 E	Leonardo Rapid Palatal Expander 12mm	\$51.90

XP Rapid Palatal Expander

The XP line of RPE, made of medical-grade stainless steel, is designed to meet the most demanding accuracy requirements, stability, and comfort. Its compact size and the chamfered shape, make it comfortable for the patient and also suitable in cases with limited space. XP's fully mechanical friction system allows expansion control avoiding the spin-back effect. The XP series doesn't use any chemical components for friction control being completely safe for the patient.

Main Features:

HOUSING OF THE ARMS IN A SINGLE PIECE BUILT: The arms are made of soft and solid steel to allow accuracy in the bending and stability in the use.

LASER WELDING OF THE ARMS: Their U-shape and the laser welding in the single-piece housing, ensure high torsion and compression resistance, eliminating risks of accidental breakage.

FUNNEL SHAPED INSERTION HOLE: The activation hole has been designed with a generous flaring funnel, to make it easier for the user to insert the expansion key.



GROUP/ITEM #	DESCRIPTION	
201-V30-0812XL	XP Rapid Palatal Expander 8mm 1-Arm	\$37.93
201-V30-1014XL	XP Rapid Palatal Expander 10mm 1-Arm	\$37.93
201-V30-1216XL	XP Rapid Palatal Expander 12mm 1-Arm	\$37.93

XP Rapid Palatal Expander 2-Arm

GROUP/ITEM #	DESCRIPTION	
201-V30-0812 X	XP Rapid Palatal Expander 8mm	\$35.95
201-V30-1014 X	XP Rapid Palatal Expander 10mm	\$35.95
201-V30-1016 X	XP Rapid Palatal Expander 12mm	\$35.95



Sia Orthodontics Products Dist. By Pozzi Orthodontics

D-Bar

**SPECIAL
Introductory
Prices**

GROUP/ITEM #	DESCRIPTION	CONTENT	
201-B30-DB16	D-Bar - Class II Corrector - Size 16	\$235.60	
201-B30-DB17	D-Bar - Class II Corrector - Size 17	\$235.60	
201-B30-DB18	D-Bar - Class II Corrector - Size 18	\$235.60	
201-B30-DB19	D-Bar - Class II Corrector - Size 19	\$235.60	
201-B30-DB20	D-Bar - Class II Corrector - Size 20	\$235.60	
201-B30-DB21	D-Bar - Class II Corrector - Size 21	\$235.60	2 Bars
201-B30-DB22	D-Bar - Class II Corrector - Size 22	\$235.60	2 Molar Sockets
201-B30-DB23	D-Bar - Class II Corrector - Size 23	\$235.60	1 Ruler
201-B30-DB24	D-Bar - Class II Corrector - Size 24	\$235.60	
201-B30-DB25	D-Bar - Class II Corrector - Size 25	\$235.60	
201-B30-DB26	D-Bar - Class II Corrector - Size 26	\$235.60	
201-B30-DB27	D-Bar - Class II Corrector - Size 27	\$235.60	
201-B30-DB T	D-Bar - Molar Socket	\$119.80	
201-B30-DB K	D-Bar - Set 24 pcs	\$2,355.90	24 Bars (2 per size) 24 Molar Sockets 24 Rulers 1 pair of Tweezer

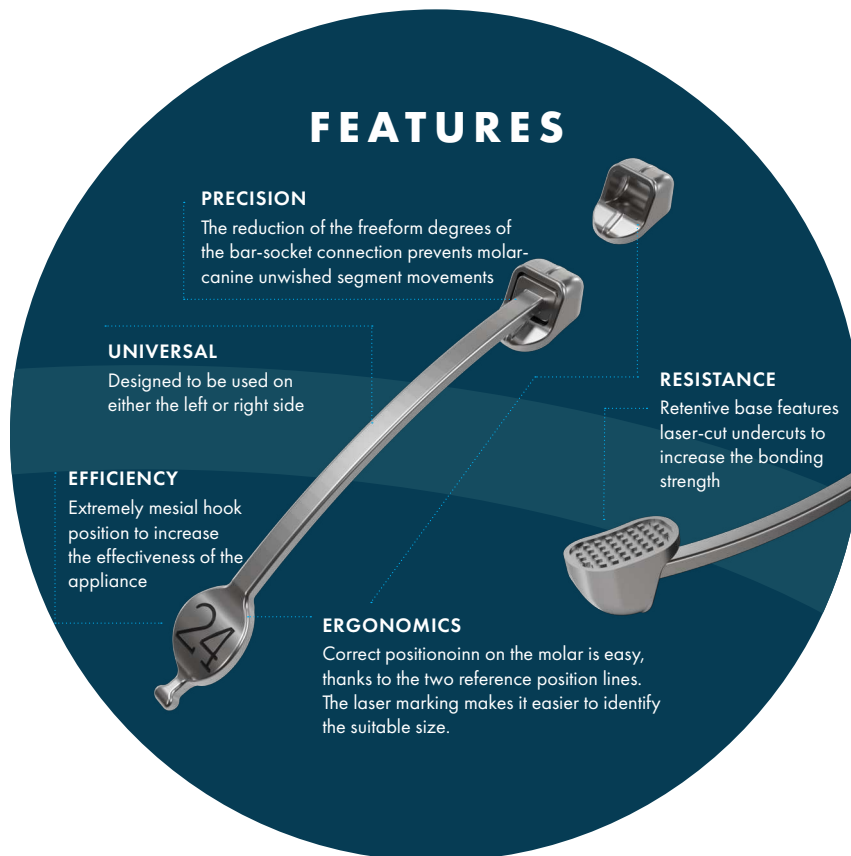

The Advantages

- ✓ **Control of the molar-canine segment.** The connection system has been designed with tight tolerances to increase treatment effectiveness by minimizing unwanted inter-arches or cuspids movements.
- ✓ **Effectiveness.** The position of the hook on the canine's mesial side increases the appliance's effectiveness by increasing horizontal forces compared to vertical extrusion.
- ✓ **Easy positioning.** The mesiodistal and occlusal-gingival positioning lines facilitate the positioning of the socket on the tooth.
- ✓ **Treatment time reduction.** Using a D-bar improves the molar relationship making the orthodontic treatment faster.
- ✓ **Comfort.** Its smooth and low-profile design improves patient comfort and compliance during treatment.

**SPECIAL
Introductory
Prices**

Expansion Screw Palatal Split

Hyrax type expansion screws are indicated to correct poor maxillomandibular relations. The most common clinical situations to apply are:

- Mixed/early permanent dentition cases.
- Posterosuperior bilateral crossbite, as a result of deficiency of the maxilla apical base.
- Anterior or posterior crossbites that are not too severe.

GROUP/ITEM #	DESCRIPTION	
200-65.05.011	Palatal Splint Expander 9mm	\$20.93
200-65.05.012	Palatal Splint Expander 11mm	\$20.93
200-65.05.013	Palatal Splint Expander 13mm	\$20.93



Expansion Screw Rapid Fan 10mm

The Hyrax type rapid fast fan expansion screw is intended for the anterior expansion of the upper arch, mounted in the anterior palatal region, commonly used in the treatment of patients with craniofacial anomaly (cleft palate).

GROUP/ITEM #	DESCRIPTION	
200-65.05.014	Expansion Screw Rapid Fan 10mm	\$28.90



Expansion Screw Standard 11mm

Morelli expansion screws are used in fixed or mobile appliances for expansion or disjunction of the dental arches.

GROUP/ITEM #	DESCRIPTION	
200-65.05.109	Expansion Screw Standard Type 11mm	\$8.60



Expansion Screw Universal 9mm

Morelli expansion screws are used in fixed or mobile appliances for expansion or disjunction of the dental arches.

GROUP/ITEM #	DESCRIPTION	
200-65.05.103	Expansion Screw Universal 9mm	\$8.60



Expansion Screw Fan Type 8mm

The Hyrax Type rapid fast fan expansion screw is intended for the anterior expansion of the upper arch, mounted in the anterior palatal region, commonly used in the treatment of patients with craniofacial anomaly (cleft palate).

GROUP/ITEM #	DESCRIPTION	
200-65.05.160	Expansion Screw Rapid Fan Type 8mm	\$17.23



Expansion Screw Mini 6.5mm

Morelli expansion screws are used in fixed or mobile appliances for expansion or disjunction of the dental arches.

GROUP/ITEM #	DESCRIPTION	
200-65.05.106	Expansion Screw Mini 6.5mm	\$8.60



Pozzi Stainless Steel Bands

Easy Stretch Pozzi Molar Bands



The Pozzi series of molar bands are fully proportional in all dimensions; diameter, height and thickness, to provide maximum strength and to prevent cement washout due to gaping. Pozzi bands are designed with a regular temper to allow for easier "stretch" adaptation. They are available in separate lefts and rights for better seating and a closer adaptation to the natural anatomy. Pozzi bands utilize Unitek® standard sizing, making switching easy and painless. If you are tired of paying high prices for your bands, then the Pozzi line is perfect for you!

GROUP/ITEM #	DESCRIPTION	RETAIL
031-M851-808	Pozzi Band Kit - Empty	\$24.63

Purchase 270 bands and receive one box FREE



SIZE	UL 29.0	UL 29.5	UL 30.0	UL 30.5	UL 31.0	UL 31.5	UL 32.0	UL 32.5
Qty.	1	1	1	1	1	1	1	1
SIZE	UL 33.0	UL 33.5	UL 34.0	UL 34.5	UL 35.0	UL 35.5	UL 36.0	UL 36.5
Qty.	2	3	4	4	4	4	4	4
SIZE	UL 37.0	UL 37.5	UL 38.0	UL 38.5	UL 39.0	UL 39.5	UL 40.0	UL 40.5
Qty.	3	2	2	2	1	1	1	1
SIZE	UL 41.0	UL 41.5	UL 42.0	Upper Left Quadrant				
Qty.	1	1	1					

GROUP/ITEM #	DESCRIPTION	RETAIL
031-MMBK54-UL	Upper Left Quadrant Kit of 54 Bands	\$53.25
031-31.21*	Upper Left Quadrant - Single	\$.53

*Specify size

SIZE	LL 29.0	LL 29.5	LL 30.0	LL 30.5	LL 31.0	LL 31.5	LL 32.0	LL 32.5
Qty.	1	1	1	1	1	1	1	1
SIZE	LL 33.0	LL 33.5	LL 34.0	LL 34.5	LL 35.0	LL 35.5	LL 36.0	LL 36.5
Qty.	2	3	4	4	4	4	4	4
SIZE	LL 37.0	LL 37.5	LL 38.0	LL 38.5	LL 39.0	LL 39.5	LL 40.0	LL 40.5
Qty.	3	2	2	2	1	1	1	1
SIZE	LL 41.0	LL 41.5	LL 42.0	Lower Left Quadrant				
Qty.	1	1	1					

GROUP/ITEM #	DESCRIPTION	RETAIL
031-MMBK54-LL	Lower Left Quadrant Kit of 54 Bands	\$53.25
031-31.11*	Lower Left Quadrant - Single	\$.53

*Specify size



GROUP/ITEM #	DESCRIPTION	RETAIL
031-MMBK54-UR	Upper Right Quadrant Kit of 54 Bands	\$53.25
031-31.20*	Upper Right Quadrant - Single	\$.53

*Specify size

SIZE	UR 29.0	UR 29.5	UR 30.0	UR 30.5	UR 31.0	UR 31.5	UR 32.0	UR 32.5
Qty.	1	1	1	1	1	1	1	1
SIZE	UR 33.0	UR 33.5	UR 34.0	UR 34.5	UR 35.0	UR 35.5	UR 36.0	UR 36.5
Qty.	2	3	4	4	4	4	4	4
SIZE	UR 37.0	UR 37.5	UR 38.0	UR 38.5	UR 39.0	UR 39.5	UR 40.0	UR 40.5
Qty.	3	2	2	2	1	1	1	1
SIZE	UR 41.0	UR 41.5	UR 42.0	Upper Right Quadrant				
Qty.	1	1	1					

SIZE	LR 29.0	LR 29.5	LR 30.0	LR 30.5	LR 31.0	LR 31.5	LR 32.0	LR 32.5
Qty.	1	1	1	1	1	1	1	1
SIZE	LR 33.0	LR 33.5	LR 34.0	LR 34.5	LR 35.0	LR 35.5	LR 36.0	LR 36.5
Qty.	2	3	4	4	4	4	4	4
SIZE	LR 37.0	LR 37.5	LR 38.0	LR 38.5	LR 39.0	LR 39.5	LR 40.0	LR 40.5
Qty.	3	2	2	2	1	1	1	1
SIZE	LR 41.0	LR 41.5	LR 42.0	Lower Right Quadrant				
Qty.	1	1	1					

GROUP/ITEM #	DESCRIPTION	RETAIL
031-MMBK54-LR	Lower Right Quadrant Kit of 54 Bands	\$53.25
031-31.10*	Lower Right Quadrant - Single	\$.53

*Specify size



Orthodontic Band Pusher & Cement Remover

Stainless steel. Time saving - two tools in one. Finely serrated band pusher on one end and an all purpose scaler on the other end.

GROUP/ITEM #	DESCRIPTION	RETAIL
007-8-606-349	Schure Dental Scaler - Band Pusher, Double ended 6.75" (16.5 cm)	\$6.71

SPECIAL
\$4.00



Unitek® is not a registered trademark of American Tooth Industries.

Easy ordering • 805-487-9868 • pozziorthodontics.com

Pozzi Stainless Steel Crowns

This stainless steel crown line is manufactured to meet the needs of all facets of dentistry. The posterior molar crowns are designed with a shallow occlusal anatomy, allowing for more healthy tooth structure after tooth reduction. The shallow occlusal cusps permit complete compatibility with opposing teeth and reduced cuspal interference during normal mastication. The crowns are parallel on the mesial and distal walls. Unlike bell-shaped crowns, these crowns will not rock or cause separation when two or more adjoining crowns are used. We have made these crowns with a thickness that prevents occlusal wear-through that sometimes occurs with the use of thinner crowns. Unlike some of the other crowns made with thinner and less durable materials, our crowns may be welded too. These are the crowns you want for making

space maintainers or Herbst appliances, or for a semipermanent restoration. Through our own research, we have determined these crowns to be of the ideal length: short enough to eliminate excess crown trimming, and long enough to provide optimum length and contour. To make our line complete to the user, we offer first and second primary molars, first and second permanent molars and first and second bicuspid. Pozzi Style 2000 crowns are a match for Unitek® Crowns. The Pozzi® Crown numbers and sizes are the same as Unitek®. Unitek® is not a trademark of American Tooth Industries.



1st Primary Molar

GROUP/ITEM #	DESCRIPTION
040-40-0022	First Primary Molar Crown Kit 72 pcs., 7 sizes
040-40-22 (+size)	Reorder pack of 5. Specify crown size and quadrant. *Example: 40-22.UL1

MOLAR CROWN KIT SPECIAL: \$283.76

Regular kit price \$302.04

CROWN SPECIAL: BUY 5 PKS, PAY \$16.85 PER PK, MIX & MATCH

Reorder a pack of five crowns \$20.60

UR	UL
1	1
2	2
3	3
4	4
5	5
6	6
7	7
LR	LL
1	1
2	2
3	3
4	4
5	5
6	6
7	7



2nd Primary Molar

GROUP/ITEM #	DESCRIPTION
040-40-0023	Second Primary Molar Crown Kit 72 pcs., 7 sizes
040-40-23 (+size)	Reorder pack of 5. Specify crown size and quadrant. *Example: 40-23UL1

MOLAR CROWN KIT SPECIAL: \$283.76

Regular kit price \$302.04

CROWN SPECIAL: BUY 5 PKS, PAY \$16.85 PER PK, MIX & MATCH

Reorder a pack of five crowns \$20.60

UR	UL
1	1
2	2
3	3
4	4
5	5
6	6
7	7
LR	LL
1	1
2	2
3	3
4	4
5	5
6	6
7	7



1st Permanent Molar

GROUP/ITEM #	DESCRIPTION
040-40-0024	First Permanent Molar Crown Kit 72 pcs., 8 sizes
040-40-24 (+size)	Reorder pack of 5. Specify crown size and quadrant. *EExample: 40-24UL-1

MOLAR CROWN KIT SPECIAL: \$283.76

Regular kit price \$302.04

CROWN SPECIAL: BUY 5 PKS, PAY \$16.854 PER PK, MIX & MATCH

Reorder a pack of five crowns \$20.60

UR	UL
1	1
2	2
3	3
4	4
5	5
6	6
7	7
LR	LL
1	1
2	2
3	3
4	4
5	5
6	6
7	7
8	8

Pozzi Stainless Steel Crowns

2nd Permanent Molar



GROUP/ITEM #	DESCRIPTION
040-40-0025	Second Permanent Molar Crown Kit - 72 pcs., 8 sizes
040-40-25(+size)*	Reorder pack of 5. Specify crown size and quadrant. *Example: 40-25UL-1

MOLAR CROWN KIT SPECIAL: \$283.76

Regular kit price \$302.04

CROWN SPECIAL: BUY 5 PKs, PAY \$16.85 PER PK, MIX & MATCH

Reorder a pack of five crowns \$20.60

UR	UL
1	1
2	2
3	3
4	4
5	5
6	6
7	7
LR	LL
1	1
2	2
3	3
4	4
5	5
6	6
7	7
8	8



1st Bicuspid

GROUP/ITEM #	DESCRIPTION
040-40-0020	First Permanent Bicuspid Crown Kit - 72 pcs., 8 sizes (uppers) 7 sizes (lowers)
040-40-20(+size)*	Reorder pack of 5. Specify crown size and quadrant. *Example: 40-20UL-1

MOLAR CROWN KIT SPECIAL: \$283.76

Regular kit price \$302.04

CROWN SPECIAL: BUY 5 PKs, PAY \$16.85 PER PK, MIX & MATCH

Reorder a pack of five crowns \$20.60

UR	UL
00	00
0	0
1	1
2	2
3	3
4	4
5	5
6	6
LR	LL
0	0
1	1
2	2
3	3
4	4
5	5
6	6



2nd Bicuspid

GROUP/ITEM #	DESCRIPTION
040-40-0021	Second Permanent Bicuspid Crown Kit - 72 pcs., 8 sizes (uppers) 7 sizes (lowers)
040-40-21(+size)*	Reorder pack of 5. Specify crown size and quadrant. *Example: 40-21UL-1

MOLAR CROWN KIT SPECIAL: \$283.76

Regular kit price \$302.04

CROWN SPECIAL: BUY 5 PKs, PAY \$16.85 PER PK, MIX & MATCH

Reorder a pack of five crowns \$20.60

UR	UL
0	0
1	1
2	2
3	3
4	4
5	5
6	6
7	7
LR	LL
0	0
1	1
2	2
3	3
4	4
5	5
6	6

Pozzi® Space Maintainers

These preformed components are available to the laboratory that chooses to form a custom band or crown space maintainer. You simply solder the tube to the band/crown, insert the maintainer rest into the tubing, and crimp it at the desired point. Your doctor can even do the crimping in the office, thereby eliminating any chance of misfitting.



Narrow Space Maintainer wire insert with rests. Pkg. of 10
GROUP/ITEM # 040-40-0006 \$44.47



Wide Space Maintainer wire insert with rests. Pkg. of 10
GROUP/ITEM # 040-40-0007 \$44.47



Narrow Space Maintainer wire insert without rests. Pkg. of 10
GROUP/ITEM # 040-40-0008 \$17.17



Wide Space Maintainer wire insert without rests. Pkg. of 10
GROUP/ITEM # 040-40-0009 \$17.17



Narrow Space Maintainer with drop loop. Pkg. of 10
GROUP/ITEM # 040-40-0010 \$26.61



Wide Space Maintainer with drop loop. Pkg. of 10
GROUP/ITEM # 040-40-0011 \$26.61



Narrow Space Maintainer Tube Pkg. of 10
GROUP/ITEM # 040-40-0012 \$51.35



Wide Space Maintainer Tube Pkg. of 10
GROUP/ITEM # 040-40-0013 \$47.90

SPECIAL: BUY 3 GET 1 FREE - MIX&MATCH OF EQUAL OR LESSER VALUE

Pozzi Wire

Pozzi® Retainer Wire (Medical Specification)

Diamond drawn: yields a perfectly round wire.

- Medium hard temper: a true 1/2 hard wire.
- Easily formed: ideal for hand forming.
- Non-brittle: can be bent 12-14 times before breaking to prevent remakes.



**BUY 4 SIZES
MIX&MATCH &
GET 1 SIZE FREE
OF EQUAL OR LESSER VALUE**

GROUP/ITEM #	DESCRIPTION	
015-19907-1	Retainer Wire Straight lengths of 14", tube .025 10 pcs.	\$4.92
015-19907-5	Retainer Wire Straight lengths of 14", tube .028 10 pcs.	\$4.92
015-19907-2	Retainer Wire Straight lengths of 14", tube .030 10 pcs.	\$5.41
015-19907-3	Retainer Wire Straight lengths of 14", tube .032 10 pcs.	\$5.45
015-19907-4	Retainer Wire Straight lengths of 14", tube .036 10 pcs.	\$5.45

Pozzi® Standard Round Wire (Medical Specification)

- High Elasticity, which permits greater manipulation of this 3/4 hard wire without danger of cracking or breaking.
- High yield point which gives the wire a greater resistance to permanent deformation.
- Uniform mechanical properties from wire to wire and batch to batch.
- Packaged in 10 - 14" straight lengths per tube. When ordering please specify item number and size.



**BUY 4 SIZES AND GET 1 SIZE FREE
OF EQUAL OR LESSER VALUE**

GROUP/ITEM #	DESCRIPTION		DESCRIPTION		DESCRIPTION			
015-19908-05	Standard Round Wire Size: .012 10/pkg.	\$4.70	015-19908-13	Standard Round Wire Size: .020 10/pkg.	\$4.80	015-19908-21	Standard Round Wire Size: .032 10/pkg	\$5.61
015-19908-07	Standard Round Wire Size: .014 10/pkg.	\$4.70	015-19908-14	Standard Round Wire Size: .021 10/pkg.	\$4.80	015-19908-22	Standard Round Wire Size: .036 10/pkg	\$5.61
015-19908-08	Standard Round Wire Size: .015 10/pkg.	\$4.70	015-19908-15	Standard Round Wire Size: .022 10/pkg.	\$4.80	015-19908-23	Standard Round Wire Size: .040 10/pkg	\$5.61
015-19908-09	Standard Round Wire Size: .016 10/pkg.	\$4.70	015-19908-16	Standard Round Wire Size: .024 10/pkg.	\$4.80	015-20016-1	Standard Round Wire Size: .045 10/pkg	\$5.61
015-19908-10	Standard Round Wire Size: .017 10/pkg.	\$4.70	015-19908-17	Standard Round Wire Size: .025 10/pkg.	\$4.80	015-20016-2	Standard Round Wire Size: .051 10/pkg	\$5.61
015-19908-11	Standard Round Wire Size: .018 10/pkg.	\$4.70	015-19908-18	Standard Round Wire Size: .026 10/pkg.	\$5.61			
015-19908-12	Standard Round Wire Size: .019 10/pkg.	\$4.70	015-19908-19	Standard Round Wire Size: .028 10/pkg.	\$5.61			
			015-19908-20	Standard Round Wire Size: .030 10/pkg.	\$5.61			

Pozzi® Cobalt Clasp Crozat Wire (Medical Specification)

- Chromium cobalt alloy. Specifically designed for the Crozat method and for fabrication of the OSAYS appliance.
- Heat-treatable: May be soldered in open flame.
- Available in 15-23 gauge.
- Coiled spools. A softer, more malleable wire saves time when making intricate bends.

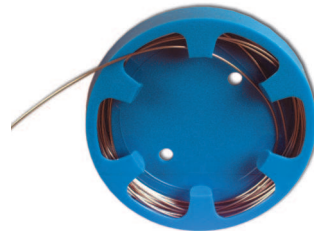

Pozzi® Standard Round Wire (Medical Specification)

- 3/4 hard wire for those who want more spring to their wire.
- Surgical-grade stainless steel.
- Spooled wire allows for increased tensile strength and less waste.

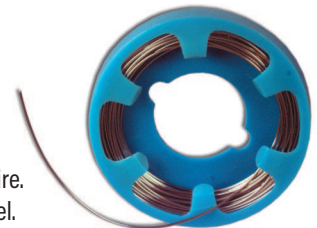

**SPECIAL: BUY 3 PIECES SAME SIZE AND GET 4th PIECE FREE
(ANY SIZE - SAME PRODUCT ONLY, OF EQUAL OR LESSER VALUE)**

Gauge Size	mm.	inch	ozs.#	ft.	Group/Item#	
22/23	0.6	.024	2/3	22	015-410/6	\$51.31
21	0.7	.028	3/4	22	015-410/7	\$51.31
20	0.8	.032	1	22	015-410/8	\$51.31
19	0.9	.036	1 1/3	22	015-410/9	\$51.31
18	1.0	.040	3/4	11	015-410/1.0	\$56.44
17	1.1	.044	1	11	015-410/1.1	\$56.44
16	1.2	.048	1 1/4	11	015-410/1.2	\$56.44
15	1.3	.052	1 1/3	11	015-410/1.3	\$56.44



Gauge Size	mm.	inch	ozs.	# ft.	Group/Item	
# 21	0.7	.028	3	90	015-400/7	\$32.60
20	0.8	.032	3	68	015-400/8	\$32.60
19	0.9	.036	3	54	015-400/9	\$32.60
18	1.0	.040	3	44	015-400/1.0	\$32.60
17	1.1	.044	3	36	015-400/1.1	\$32.60
16	1.2	.048	3	30	015-400/1.2	\$32.60
15	1.3	.052	3	26	015-400/1.3	\$32.60



Pozzi Super BP Ball Clasp - Series 2000

This improved ball clasp is made of high-grade #304 stainless steel wire and accepts severe bends without fracturing. The round head is approximately twice the diameter of the wire shaft and will not irritate tissue. These clasps are made from diamond-drawn wire and have a bright, clean finish. In our opinion, other ball clasps on the market today have a lower tensile strength and an oval-shaped head that does not possess adequate retention required by retainers. If you are looking for a better ball clasp to give superior retention on your removable appliances, try the 2000 series.

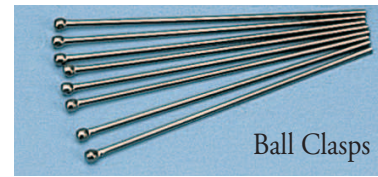

Available in three sizes.

GROUP/ITEM #	DESCRIPTION	
013-19814	Ball Clasp 2000, Size .028, Pkg. 100 pcs.	\$38.78
013-19815	Ball Clasp 2000, Size .032, Pkg. 100 pcs.	\$38.78
013-19815/6	Ball Clasp 2000, Size .036, Pkg. 100 pcs.	\$38.78

SPECIAL:
\$23.86
Per Pkg.



Pozziloy (Medical Specification)

Pozziloy retainer wire, is our own special formulation of nickel cobalt wire, available in a blue, soft, heat-treatable (1400/1600 N/sq.mm) tensile. This chromium-cobalt base alloy is highly stainless and mechanically more resistant to breakage. Each wire is color coded blue at the tip, and is 14 inches in length. This wire is made from a vacuum-fused alloy, diamond-drawn to obtain leveled and highly resistant forces. Packaged in a ten pack, it is available in .028, .030, .032 and .036.



GROUP/ITEM #	DESCRIPTION	
040-40-0002	Pozziloy .028	\$28.51 ea.
040-40-0003	Pozziloy .030	
040-40-0004	Pozziloy .032	
040-40-0005	Pozziloy .036	\$34.18 ea.

SPECIAL: BUY 4
GET 1 FREE!
OF EQUAL OR LESSER VALUE
MIX & MATCH

Pozzi® Half Round Wire (Medical Specification)

Half round, semi-hard, type-304 tempered stainless steel wire to be used for reinforcement of dentures and prosthodontic appliances. Also used to fabricate special clasps. Precision cut to 12" (30.5 cm) in length. Diamond drawn for brightness, ultrasonically cleaned for dental use. Available in six (6) different sizes. Packaged in 6 pieces of 12" straight length per tube.

GROUP/ITEM #	DESCRIPTION	
015-20074	12" Half Round Wire .90 mm 6/pk	\$5.17 ea.
015-20075	12" Half Round Wire 1 mm 6/pk	\$5.17 ea.
015-20076	12" Half Round Wire 1.2 mm 6/pk	\$5.17 ea.
015-20077	12" Half Round Wire 1.25 mm 6/pk	\$7.47 ea.
015-20079	12" Half Round Wire 1.7 mm 6/pk	\$8.91 ea.

SPECIAL: BUY 4
GET 1 FREE!
OF EQUAL OR LESSER VALUE
MIX & MATCH

Pozzi® Lingual Bars

Stainless steel lingual bars in four sizes: small, medium, large, extra large. More retention due to large serrated anchorage surface.



GROUP/ITEM #	DESCRIPTION	
015-20081	Lingual Bar, Small - 55 mm. 1/pkg.	\$3.04 ea.
015-20082	Lingual Bar, Medium - 65 mm. 1/pkg.	
015-20083	Lingual Bar, Large - 75 mm. 1/pkg.	
015-20084	Lingual Bar, X-Large - 85 mm. 1/pkg.	

SPECIAL: BUY 5
MIX & MATCH
PAY \$2.62

Pozzi® Wire & Sheet Metal Gauge Precision Instrument

Light-weight stainless steel. Measures round and rectangular wire with gauge and inch sizes. The only device which helps to verify sizes and maintains quality control. The wire gauge is a template which is used to measure the gauge or thickness of sheet metal or wire. Around the edge are graduated, numbered slots which fit wire or sheet metal. The metal or wire is tried in the various slots until it just fits without being forced.

GROUP/ITEM #	DESCRIPTION	
014-19895	Wire Gauge	\$60.78

SPECIAL
\$47.09

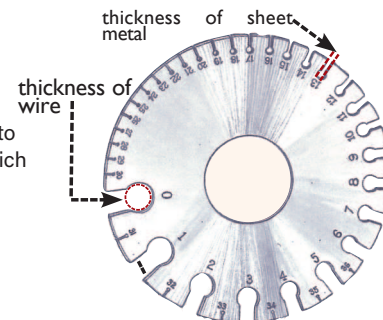

Soldering Tweezers

Stainless steel soldering tweezers with plastic handles for protection from heat of soldering. Available in two styles: straight or curved tipped.



GROUP/ITEM #	DESCRIPTION		
007-6400-1	Soldering Tweezers Straight Tip 6½"	\$17.17	SPECIAL: \$13.70
007-6400-2	Soldering Tweezers Curved Tip 6¼"	\$17.17	SPECIAL: \$13.70

Pozzi® All Purpose Scissors

7" long, stainless steel, autoclavable 143° C, with plastic handles.

SPECIAL
\$30.05

GROUP/ITEM #	DESCRIPTION	
007-20012	All Purpose Scissors	\$37.68



Solder & Accessories



Premium Ticonium Wire

Premium quality, round clasp wire specially suited for casting with PREMIUM 100 alloy. 12" length (30cm) each wire. Comes 5 Sticks in a tube.



GROUP/ITEM #	DESCRIPTION	
015-61622	Premium Ticonium Wire 18-gauge	\$22.84



Dental Alloy by Mesa distributed by ATI

Cobalt based A alloy for prostheses, type 5



GROUP/ITEM #	DESCRIPTION	
110-40090025A	Magnum VIP-A Cobalt Alloy, 1 kg	\$310.00

THE HISTORY OF POZZI ORTHODONTIC SILVER SOLDER



The Pozzi family has been manufacturing silver solders since 1934. From the melting of different alloys, including 65% of the purest silver, up to the making of rough bulk ingots, the quality control has been consistent, and the resulting product is remarkable. Of course, our solder does not have any cadmium or any other impurities. The rolling of the rough ingots to obtain square and round wires takes at least fifteen steps. The lamination is done with the most precise

gauged rolling mill in the industry. The high content of silver in our orthodontic solder means that very little material is needed in the soldering process, and the possibility of oxidation is nearly eliminated. Solders with a low silver content tend to oxidize heavily due to impurities. The combination of the ingredients in our silver solder and the high quality flux make this product the very best available in the world market.

Silver Solder

Pozzi® Malibu™ Orthodontic Laboratory Silver and Brazing Solder

CADMIUM & NICKEL FREE

A cadmium-free alloy with free flowing and ductile characteristics. Easy to use. Manufactured in the U.S.A. for the Pozzi brand.

GROUP/ITEM #	DESCRIPTION		SPECIAL PRICE
031-32.50.001	1oz Spool	\$135.25	\$94.30
031-32.50.005	5oz Spool	\$676.18	\$471.15
031-32.50.050	50oz Spool	\$6,762.04	\$4,715.00

Silver Solder A50N

With the addition of nickel the A50N offers good strength and flow characteristics and works well on stainless steel and carbide.

GROUP/ITEM #	DESCRIPTION	
A50N	Pozzi Ortho Silver Solder .032 - 1oz	\$49.42
A50N-5BLK	Pozzi Ortho Silver Solder .032 - 5oz	\$223.97

Pozzi® Malibu™ Flux

Item # 031-32.50.100



SPECIAL:
\$10.56

Pozzi Malibu Flux 6.5oz - \$13.57



Diameter	Melting Point	Silver Content
1/32" (.79 mm)	1145° F 618° C	56%

- 1 Good strength and ductility on nickel alloys to help avoid stress corrosion cracking.
- 2 Good color match on stainless steel.
- 3 Excellent fluidity that promotes penetration for good strength and elongation.

iNMAN Power Component Kit



For the fabrication of low-cost distalization appliances, the Inman Power Component sets the standard in the application and control of distalization force.

Now any quality laboratory can offer their customers appliances that are simple to adjust, completely controllable and are comfortable for patients. The Inman IPC provides all the necessary components to make an endless variety of quality appliances. With the IPC kit, 5 distalizers or a combination of distalizers and e-arches can be fabricated. The IPC's compressed coil spring provides an easy-to-adjust force controlled by a unidirectional sliding lock. The lock can be advanced 1-mm "click" at a time for accurate, predictable activation. The concept and function of the IPC is simplistic beauty and allows adjustment by the patient or patient's guardian, making it a very efficient appliance choice. In appliance fabrication, time is money, and with the Inman IPC, you will spend less time to make a quality product.

The Inman Power Component is sold as a kit, or you can purchase all the individual parts separately.

E-ARCH



Ideal for transverse expansion of maxillary and mandibular arches where patient compliance is a concern. A tube-like framework is located on half of the arch, which is connected to the IPC on the opposing side.

IPC DISTALIZER W/ NANCE BUTTON



This appliance provides effective distal molar movement and limits mesial movement through the incorporation of a Nance button. The IPC extends through tubes to guide the maxillary first molars during distalization.

IPC DISTALIZER



USING TRANSVERSE EXPANSION

Transverse expansion and molar distalizer in one appliance. Trombone components add support during expansion and eliminate the need to cut any wires or supports before activating the Distalizer IPC components.

**MIN - \$35.13
PER APPLIANCE**
**MAX - \$50.25
PER APPLIANCE**



**MIN - 5
APPLIANCES PER KIT**
**MAX - 10
APPLIANCES PER KIT**

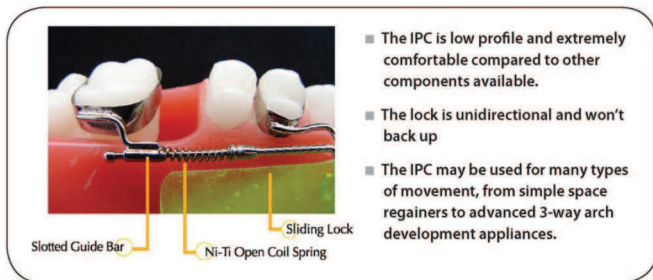

- The IPC is low profile and extremely comfortable compared to other components available.
- The lock is unidirectional and won't back up
- The IPC may be used for many types of movement, from simple space regainers to advanced 3-way arch development appliances.

USAGE

The infinite number of uses of this simple, dependable component will develop over time, and we encourage you to use your imagination and knowledge to help us discover all of the IPC's potential. Inman Orthodontic Laboratories will work with you on any ideas you may have for the IPC, and we will reward you for documented case results using your designs.

THE FORCES

The IPC compresses coil springs with an easy-to-adjust unidirectional sliding lock. The lock can be advanced 1-mm "click" at a time for accurate, predictable activation.

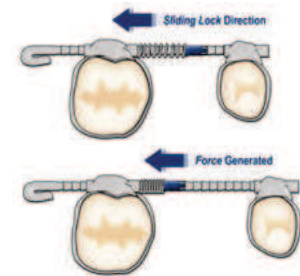

ACTIVATING THE IPC APPLIANCES *Activation Tool*



GROUP/ITEM #	DESCRIPTION	
031-IPC01K	The IPC Kit (contains: (10) IPC Assy. (10) Welded Tubes Combination, (5) Plain Tubes 50mm, (8) Plain Tubes 4.5 mm, (1) Spool NiTi Open Coil Spring Wire	\$311.58
The IPC Quantity Package:		
031-IPC02X20	Qty 20 - IPC Inman Power Component Assy 20 Pak	\$399.36
Refills for the IPC Kit:		
031-IPC02	Qty 10 - IPC Inman Power Component Assy	\$199.68
031-IPC03	Qty 10 - Welded tube wire combination, 4.5 mm tube with 0.040 inside diameter for welding to 60 mm 0.036 wires.	\$68.64
031-IPC04	Qty 05 - Plain tube, 50 mm in length with inside diameter of 0.040	\$13.74
031-IPC05	Qty 08 - Plain tube, 4.5 mm with inside diameter of 0.040	\$10.00
031-IPC06	Qty 01 - Spool of 012/.045 NiTi open coil spring wire, approx. 15.5" length	\$24.96

High-Impact Acrylic Resin & Accessories

Pozzi® Ortho Resin - Cold Cure High Impact - Premium Resin - "Lo-Flo"

Pozzi Ortho Resin is a self-curing, high-impact acrylic that was developed for orthodontic use in making strong and attractive appliances and retainers. The powder is a "Lo-Flo" formulation that will rapidly absorb the monomer and will not slump, flow or run. Plastic thickness and form can be rapidly accomplished because when Pozzi Ortho powder and liquid are sprayed on the stone cast, the acrylic will stay put and even. Pozzi Ortho Resin Kit is supplied with clear powder and pink or clear liquid. Kit contains: 16 oz. powder, 8 oz. pink or clear liquid, dropper, a 3oz. jet dispenser, and instruction sheet.



Group/Item #	Description		
033-19822/P	Pozzi Ortho Acrylic 1 lb. kit, pink liquid	\$53.52	\$48.17
033-19822/C	Pozzi Ortho Acrylic 1 lb. kit, clear liquid	\$53.52	\$48.17
033-19823/P	Pozzi Ortho Acrylic 25 lb. kit, pink liquid	\$873.23	\$785.90
033-19823/C	Pozzi Ortho Acrylic 25 lb. kit, clear liquid	\$873.23	\$785.90
033-20024/P	Pozzi Ortho Liquid, 8 oz. pink	\$15.32	\$13.78
033-20024/C	Pozzi Ortho Liquid, 8 oz. clear	\$15.32	\$13.78
033-20032	Pozzi Ortho Powder, 16 oz.	\$40.56	\$36.50
033-20032/7	Pozzi Ortho Acrylic 7lb clear powder	\$274.50	\$247.05
033-20033	Pozzi Ortho Powder, 25 lb. clear powder	\$820.35	\$738.31
033-20034/P	Pozzi Ortho Liquid, 1 gal. pink	\$80.37	\$72.33
033-20034/C	Pozzi Ortho Liquid, 1 gal. clear	\$80.37	\$72.33

Pozzi® Ortho Color Liquids

Use of these colors results in beautiful and unique appliances. Colors are dense and bright and are manufactured by our factory in Oxnard, California.



Color Guides

A display of 13 fun colors to assist patients in choosing their color.



SPECIAL
\$42.16

GROUP/ITEM #	DESCRIPTION	
041-RP6000-00	Color Shade Guide	\$50.42

		SPECIAL - \$7.25	
GROUP/ITEM #	DESCRIPTION		
041-RP6031-01	1 oz. Pozzi Ortho Color Liquid "C"	Pink	\$9.23
041-RP6122-01	1 oz. Pozzi Ortho Color Liquid "A"	Clear	\$9.23
041-RP6123-01	1 oz. Pozzi Ortho Color Liquid "B"	Trans. Pink	\$9.23
041-RP6124-01	1 oz. Pozzi Ortho Color Liquid "D"	Red	\$9.23
041-RP6125-01	1 oz. Pozzi Ortho Color Liquid "E"	Purple	\$9.23
041-RP6126-01	1 oz. Pozzi Ortho Color Liquid "F"	Magenta	\$9.23
041-RP6127-01	1 oz. Pozzi Ortho Color Liquid "G"	Orange	\$9.23
041-RP6128-01	1 oz. Pozzi Ortho Color Liquid "H"	Fluor. Yellow	\$9.23
041-RP6129-01	1 oz. Pozzi Ortho Color Liquid "I"	Green	\$9.23
041-RP6130-01	1 oz. Pozzi Ortho Color Liquid "L"	Turquoise	\$9.23
041-RP6131-01	1 oz. Pozzi Ortho Color Liquid "M"	Blue	\$9.23
041-RP6132-01	1 oz. Pozzi Ortho Color Liquid	Black	\$9.23
041-RP6133-01	1 oz. Pozzi Ortho Color Liquid	Gold	\$9.23

		SPECIAL - \$24.15	
GROUP/ITEM #	DESCRIPTION		
041-RP6031-04	4 oz. Pozzi Ortho Color Liquid "C"	Pink	\$29.48
041-RP6122-04	4 oz. Pozzi Ortho Color Liquid "A"	Clear	\$29.48
041-RP6123-04	4 oz. Pozzi Ortho Color Liquid "B"	Trans. Pink	\$29.48
041-RP6134-04	4 oz. Pozzi Ortho Color Liquid "D"	Red	\$29.48
041-RP6135-04	4 oz. Pozzi Ortho Color Liquid "E"	Purple	\$29.48
041-RP6136-04	4 oz. Pozzi Ortho Color Liquid "F"	Magenta	\$29.48
041-RP6137-04	4 oz. Pozzi Ortho Color Liquid "G"	Orange	\$29.48
041-RP6138-04	4 oz. Pozzi Ortho Color Liquid "H"	Fluor. Yellow	\$29.48
041-RP6139-04	4 oz. Pozzi Ortho Color Liquid "I"	Green	\$29.48
041-RP6130-04	4 oz. Pozzi Ortho Color Liquid "L"	Turquoise	\$29.48
041-RP6141-04	4 oz. Pozzi Ortho Color Liquid "M"	Blue	\$29.48
041-RP6142-04	4 oz. Pozzi Ortho Color Liquid	Black	\$29.48
041-RP6143-04	4 oz. Pozzi Ortho Color Liquid	Gold	\$29.48

		SPECIAL - \$29.28	
GROUP/ITEM #	DESCRIPTION		
041-RP6031-08	8 oz. Pozzi Ortho Color Liquid "C"	Pink	\$49.41
041-RP6122-08	8 oz. Pozzi Ortho Color Liquid "A"	Clear	\$49.41
041-RP6123-08	8 oz. Pozzi Ortho Color Liquid "B"	Trans. Pink	\$49.41
041-RP6124-08	8 oz. Pozzi Ortho Color Liquid "D"	Red	\$49.41
041-RP6125-08	8 oz. Pozzi Ortho Color Liquid "E"	Purple	\$49.41
041-RP6126-08	8 oz. Pozzi Ortho Color Liquid "F"	Magenta	\$49.41
041-RP6127-08	8 oz. Pozzi Ortho Color Liquid "G"	Orange	\$49.41
041-RP6128-08	8 oz. Pozzi Ortho Color Liquid "H"	Fluor. Yellow	\$49.41
041-RP6129-08	8 oz. Pozzi Ortho Color Liquid "I"	Green	\$49.41
041-RP6130-08	8 oz. Pozzi Ortho Color Liquid "L"	Turquoise	\$49.41
041-RP6131-08	8 oz. Pozzi Ortho Color Liquid "M"	Blue	\$49.41
041-RP6132-08	8 oz. Pozzi Ortho Color Liquid	Black	\$49.41
041-RP6133-08	8 oz. Pozzi Ortho Color Liquid	Gold	\$49.41

		SPECIAL - \$68.14	
GROUP/ITEM #	DESCRIPTION		
041-RP6031-16	1 pint Pozzi Ortho Color Liquid "C"	Pink	\$98.67
041-RP6122-16	1 pint Pozzi Ortho Color Liquid "A"	Clear	\$98.67
041-RP6123-16	1 pint Pozzi Ortho Color Liquid "B"	Trans. Pink	\$98.67
041-RP6134-16	1 pint Pozzi Ortho Color Liquid "D"	Red	\$98.67
041-RP6135-16	1 pint Pozzi Ortho Color Liquid "E"	Purple	\$98.67
041-RP6136-16	1 pint Pozzi Ortho Color Liquid "F"	Magenta	\$98.67
041-RP6137-16	1 pint Pozzi Ortho Color Liquid "G"	Orange	\$98.67
041-RP6138-16	1 pint Pozzi Ortho Color Liquid "H"	Fluor. Yellow	\$98.67
041-RP6139-16	1 pint Pozzi Ortho Color Liquid "I"	Green	\$98.67
041-RP6130-16	1 pint Pozzi Ortho Color Liquid "L"	Turquoise	\$98.67
041-RP6141-16	1 pint Pozzi Ortho Color Liquid "M"	Blue	\$98.67
041-RP6142-16	1 pint Pozzi Ortho Color Liquid	Black	\$98.67
041-RP6143-16	1 pint Pozzi Ortho Color Liquid	Gold	\$98.67

High-Impact Acrylic Resin & Accessories

Pozzi® Spruzzo™ Colored Acrylic Powders -Solid Colors

Pozzi solid colored powders were designed for use with our clear monomer. These colors were created for those wanting a more solid color appearance. Designed for use with the salt and pepper technique, these colors are sure to catch every teenager's eye! Each color comes in a 4 ounce easy-to-use spray bottle and is available in many popular colors.



SPECIAL: \$12.42

4 OUNCE BOTTLE	GROUP/ITEM #	DESCRIPTION		
	040-40-0034	Spruzzo Powder 4 oz.	Yellow	\$16.39
	040-40-0035	Spruzzo Powder 4 oz.	White	\$16.39
	040-40-0036	Spruzzo Powder 4 oz.	Orange	\$16.39
	040-40-0037	Spruzzo Powder 4 oz.	Black	\$16.39
	040-40-0038	Spruzzo Powder 4 oz.	Brown	\$16.39
	040-40-0039	Spruzzo Powder 4 oz.	Blue	\$16.39
	040-40-0040	Spruzzo Powder 4 oz.	Red	\$16.39
040-40-0040/SG	Spruzzo Shade Guide		\$31.07	SPECIAL: \$21.75

Pozzi® Spruzzo™

Colored Acrylic Powders - Solid and Glitter Colors

Pozzi blended colored powders were designed for use with our clear monomer. These colors were created for those wanting a more solid color appearance. Designed for use with the salt-and-pepper technique, these colors are sure to catch every teenager's eye! Each color comes in a 4-ounce easy-to-use spray bottle and is available in many popular colors.



GROUP/ITEM #	DESCRIPTION			Special
040-40-0050	Spruzzo Glitter Powder 4 oz.	Yellow Glitter	\$34.39	\$25.95
040-40-0051	Spruzzo Glitter Powder 4 oz.	Green Glitter	\$34.39	
040-40-0052	Spruzzo Glitter Powder 4 oz.	Clear Glitter	\$34.39	
040-40-0053	Spruzzo Glitter Powder 4 oz.	Hot Pink Glitter	\$34.39	

Therm-o-Flex Transparent

For Mouth Guards and Hard Bite Splints

Advantages:

- Adjustable Softness
- Reduced Chair Time
- Everlasting Fit
- Excellent Bond
- Patient Comfort
- Athletic Safety

Also available in the Pink Fibered for Hybrid Dentures and to stabilize Lower Full Dentures.

GROUP/ITEM #	DESCRIPTION	
034-TF3347	Therm-O-Flex Acrylic Transparent Powder – 1 lb.	\$68.90
034-TF3305	Therm-O-Flex Acrylic Transparent Powder – 6 lb.	\$348.00
034-TF3307	Therm-O-Flex Acrylic Transparent Powder – 25 lbs.	\$1,190.00
034-TF3306	Therm-O-Flex Acrylic Liquid – 1 Quart	\$51.90
034-TF3348	Therm-O-Flex Acrylic Liquid – 11 oz.	\$32.10
034-TF3311	Therm-O-Flex Pink Fiber 1 lb.	\$86.20
034-TF3312	Therm-O-Flex Pink Fiber 6 lb.	\$375.80



Plastic Teeth For All Your Lab Needs

Bambino® Teeth

**SPECIAL: GET 10
MIX&MATCH
\$8.37 A CARD**



The Bambino tooth is an aesthetic and functional solution to the problem of the empty spaces left by deciduous teeth.

Made of a copolymer cross-linked resin, this tooth line guarantees impermeability to infiltration of fluids and bacteria, thus preventing discoloration and changing of dimensional character. Studied and developed by orthodontic specialists as a simplified alternative to orthodontic appliances, these teeth are ideal for use as a space maintainer to ensure a correct line of teeth where both articulation and aesthetics are concerned. Use of these teeth in articular rehabilitations allows for proper mastication, which can only be obtained with perfect articular balance. Available in a single mold—upper and lower anteriors and upper and lower posteriors. Mounted on dark plastic blocks in 2 shades: 59 (milk-white), 61 (yellow straw-white).

GROUP/ITEM #	DESCRIPTION	
084-10077*	Justi Bambino Deciduous Upper Anterior Card (1x6)	\$13.50
084-10078*	Justi Bambino Deciduous Lower Anterior Card (1x6)	\$13.50
084-10177*	Justi Bambino Deciduous Upper Posterior Card (1x4)	\$13.50
084-10178*	Justi Bambino Deciduous Lower Posterior Card (1x4)	\$13.50
084-10278*	Justi Bambino Deciduous Combination Card (1x20)	\$13.50
084-10279*	Justi Bambino Deciduous Teeth Starter Kit (20 cards)	\$54.00

Pozzi® Retainer Cases

BEST VALUE!

BUY 20, & GET 25% OFF



The large and medium retainer boxes are virtually indestructible and feature "the living hinge" design with a locking mechanism. The medium case is perfect for an upper and lower retainer combination and the large size accommodates a functional type appliance. Your patients will love the combination key hole air vent. They will never lose an Expansor again. A label is provided for the patient's name, address, and phone number.

GROUP/ITEM #	DESCRIPTION	
040-65-0058LB	Large Retainer Case Blue 1/Pk. (pictured)	\$1.26
040-65-0058LP	Large Retainer Case Purple 1/Pk.	\$1.26
040-65-0058MB	Medium Retainer Case Blue 1/Pk.	\$1.22
040-65-0058MP	Medium Retainer Case Purple 1/Pk. (pictured)	\$1.22

Justi® Kura Pressure Pot

Sturdy, absolutely safe, very practical and has a large, 6-quart capacity. Made entirely of stainless steel, and the parts are available individually. This curing pot was designed to satisfy the needs of the modern technician.

GROUP/ITEM #	DESCRIPTION	
070-46-0001	Justi Kura Pot with air hose	\$470.71
070-46-0002	Air Intake Valve for Justi Kura Pot	\$7.46
070-46-0004	Safety Relief Valve for Justi Kura Pot	\$27.60
070-46-0005	Pressure Release Valve for Justi Kura Pot	\$19.64
070-46-0006	Air Pressure Gauge for Justi Kura Pot	\$44.34
070-46-0007	Small Seal for Pressure Pot Safety Lock	\$5.25
070-46-0023	Air Supply Hose	\$30.20



Tiger Products dist. By Pozzi Orthodontics

Deluxe Ortho Boxes

Suitable for mouth-guards, night-guards, and snoring devices. It features vent holes and a key holder. Deluxe Ortho Box is 1 ¼" Deep

GROUP/ITEM #	DESCRIPTION	
203-DO-12MIX	12 Deluxe Ortho Box 1 ¼"	\$12.93
203-DO-25*	25 Deluxe Ortho Box 1 ¼"	\$23.25

Color: Black (BK), Clear (C), Forest Green (FG), Sky Blue (SB), Orange (OR), Pink (PK), Purple (PR), Red (R), Royal Blue (RB), White (W), Yellow (Y)

* DO-25 Choose Color



Ortho Boxes

An attractive container for storing retainers, mouth guards, bleaching trays, and splints. Made of flexible plastic, with a hinge design and a secure latching mechanism. These boxes are ideal for patients with removable appliances. Ortho Box is 1" Deep

GROUP/ITEM #	DESCRIPTION	
203-0-25MIX	25 Ortho Box 1" Mixed Colors	\$20.50
203-0-25*	25 Ortho Box 1"	\$20.50

Color: Beige (T), Black (BK), Clear (C), Forest Green (FG), Green (G), Sky Blue (LB), Orange (O), Peach (P), Pink (PK), Purple (PR), Red (R), Royal Blue (RB), Silver (S), Violet (V), White (W), Yellow (Y)

*0-25 Choose color



Deep Deluxe Ortho Boxes

Made of flexible polypropylene material that will not break and resist crushing. This crown and bridge box has a positive lock-in mechanism. Top and bottom connect with a flexible hinge. It is an attractive crown and bridge tooth box that is available in a wide variety of fun colors to work with.

GROUP/ITEM #	DESCRIPTION	
203-DD-25MIX	25 Deluxe Ortho Box 1 ½" Mix Colors	\$30.70
203-DD-25*	25 Deluxe Ortho Box 1 ½"	\$30.70

Color: Black (BK), Clear (C), Forest Green (FG), Sky Blue (SB), Purple (PR), Red (R), Royal Blue (RB), White (W), Yellow (Y)

*DD-25 Choose color



Aligner Boxes

NEW! Slim line aligner & retainer case offers portability and convenience in a compact plastic storage box

GROUP/ITEM #	DESCRIPTION	
203-AO-12MIX	12 Aligner Boxes – Plain Assorted Colors	\$9.87
203-AO-2*	200 Aligner Boxes	\$100.87

Color: Black (BK), Clear (C), Forest Green (FG), Green (G), Sky Blue (SB), Purple (PR), Red (R), Royal Blue (RB), White (W)

*AO- 2 Choose Color



Plaster Complete Traps

Safe, reliable, and sanitary alternatives to metal plaster traps. Prevents clogged drains and expensive plumbing repairs by using disposable trap under every sink. The sanitary system catches all plasters and damaging materials heavier than water. Prevents leaks and spills. Easy to install and to change, no tools necessary. Complete Kit (Bucket with Lid, Two Fittings & Hose Set)

GROUP/ITEM #	DESCRIPTION	
203-DPT-3C	Plaster Complete Traps 3 ½ gallon. Height-11", Diameter-12½"	\$61.40
203-DPT-5C	Plaster Complete Traps 5 gallons. Height-14½", Diameter-12½"	\$65.78



Refill Traps

3 ½" or 5 Gallon Bucket with Lid and Two Attached Fittings.

GROUP/ITEM #	DESCRIPTION	
203-DPT-3R	Disposable Refill Trap 3 ½ gallon. Height-11", Diameter-12½"	\$26.32
203-DPT-5R	Disposable Refill Trap 5 gallon. Height-14½", Diameter-12½"	\$28.58



Orthodontic High Design dist. By Pozzi Orthodontics

Thermoplastic Disc Aligners

MemoClearPro is a state-of-the-art clear thermoplastic copolyester (PET-G) specifically designed for aligners and aesthetic dental devices.

GROUP/ITEM #	DESCRIPTION	
204-3434	Thermoplastic Disc 85 x 125mm Round	\$36.58
204-3434-100	Thermoplastic Disc 85 x 125mm Round - 100	\$170.90
204-3435	Thermoplastic Disc 1.0 x 125mm Round	\$39.77
204-3435-100	Thermoplastic Disc 1.0 x 125mm Round - 100	\$183.68

SPECIAL
Introductory
Prices

Unique features

It features resilience, memory and transparency that make it unique in its kind. Its high biocompatibility makes it suitable for clinical use (aligners, splints, retainers).

Versatile

The wide range of thicknesses and accessories allows a versatile use of the MemoClearPro: aligners for dental displacements, restraints, expansions, bruxism, occlusal increases, retainers, splints, etc



Compatible

MemoClearPro fits to most thermoforming machines on the market (vacuum/pressure molding machines) and it is easy to process and compatible with acrylic and light-curing resins.

Thickness		Round	Round	Square
mm	inch	Ø 125mm (4,92 inch)	Ø 120mm (4,72 inch)	127x127mm (5x5 inch)
0,50	0.020	TP-3431	TP-3449	TP-3441
0,625	0.025	TP-3432	TP-3450	
0,75	0.030	TP-3433	TP-3439	TP-3443
0,85	0.035	TP-3434	TP-3451	
1,0	0.040	TP-3435	TP-3440	TP-3445
1,5	0.060	TP-3437	TP-3452	TP-3447
2,0	0.080	TP-3438		
Pk 20 sheets				
Also available package of 100 sheets, add "-100" to the item code				

SPECIAL
Introductory
Prices



Half Moon

It accurately removes the plastic on the aligner for inserting button, accessories etc...

GROUP/ITEM #	DESCRIPTION	
204-001-084/SM	Cold Smart Plier Half Moon	\$172.90



Hole Key

It makes holes on the aligner for inserting elastics for 2nd/3rd Class traction, intrusion, etc...

GROUP/ITEM #	DESCRIPTION	
204-001-085/SM	Cold Smart Plier Hole Key	\$172.90



Triangular

It perfectly contours the edges of the plastic for a super-fast and precise finish of aligners

GROUP/ITEM #	DESCRIPTION	
204-001-087/SM	Cold Smart Plier Triangular	\$172.90

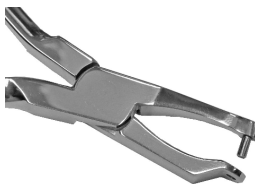

Aligner Punch

It makes holes to adhere to attachments by increasing the retention of the aligner, or to insert an elastic for dental movements

GROUP/ITEM #	DESCRIPTION	
204-001-088/SM	Cold Smart Plier Aligner Punch	\$172.90



Orthodontic High Design dist. By Pozzi Orthodontics

Smart Pliers HYBRID Collection

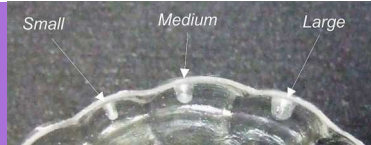

**SPECIAL
Introductory
Prices**

Activation small, medium & large

The most sophisticated tools for controlling dental movements in the vestibular-lingual direction. The tiny design of Activation pliers allows the orthodontist to operate in the tiniest areas of the aligner for an unlimited series of interventions. With Small, activation points can be created in the lower incisors area; with Medium the movements in the upper laterals and the torque can be controlled; while cuspids and centrals are managed by using Large. Remember this basic rule: before creating activation points and lines, you must neutralize the black hole area by using Flattening, Spacing, with the "waxing" and "opening" method.



GROUP/ITEM #	DESCRIPTION	
204-001-074/SM	Activation Pliers - Small	\$172.90
204-001-079/SM	Activation Pliers - Medium	\$172.90
204-001-080/SM	Activation Pliers - Large	\$172.90



Vertical for rotations

A design engineered to create activation lines in a vertical direction for optimal rotations control. The couple of forces produced by Vertical, allows greater regularity and speed of movement.



GROUP/ITEM #	DESCRIPTION	
204-001-086/SM	Vertical Pliers - Small	\$172.90



Torque Small

The torque control in the front dental segments in patients wearing aligners, has always been a problem for orthodontists. Now it is possible with the help of Torque Small and Large. The special tip design, creates an elongated shaped activation point for better movement control.



GROUP/ITEM #	DESCRIPTION	
204-001-082/SM	Torque Pliers - Small	\$172.90
204-001-083/SM	Torque Pliers - Large	\$172.90

Lateral to open and close spaces

It creates activation points for dental movements in a mesial or distal direction. Lateral has a design that fits to the proximal surface of the tooth for movements optimal control.



GROUP/ITEM #	DESCRIPTION	
204-001-076/SM	Lateral Pliers	\$172.90



Retention to make hooks

If the aligner is not stable, you don't get the patient's collaboration, the forces are not optimally transmitted, and you will have to make a new aligner. No longer now! With Retention you can create Adams clasps directly on the aligner. Choose the value corresponding to the size of the hook you want to make, on the graduated scale, and in a few seconds of thermoregulation, your aligner will be perfectly adherent to the dental arch.



GROUP/ITEM #	DESCRIPTION	
204-001-073/SM	Retention Pliers	\$ 172.90



iThermal the key of the ThermalOrth Philosophy systems

**SPECIAL
Introductory
Price**

iThermal heats the pliers in just a few seconds and creates an even temperature at the tip of the tool, essential condition for a proper thermoforming.

iThermal is essential to the orthodontist who can modify aligners with simplicity, ease and precision.

GROUP/ITEM #	DESCRIPTION	PRICE
204-001-301	iThermal Induction Temp Control Induction	\$412.62



THERMAL PROCESS: WHEN?

iThermal is essential to obtain a permanent deformation of the plastic whilst making buttons, bump planes and in operations on aligners over 1 mm thick.

iThermal technical data sheet

Width	90 mm
Length	210 mm
Height	90 mm
Net weight	0.9 kg
Gross weight	1.2 kg
Connection voltage	230 v AC 50/60 Hz
Absorption	100 W



GROUP/ITEM #	DESCRIPTION	PRICE
204-001-300	Timer	\$33.35

Pozzi Waxes

Base Plate Wax

Three options available:

Medium Soft: dependable wax that boils out clean, reasonably priced and polishes to a high shine.

Medium Hard: same as Medium Soft but formulated with higher melting waxes and is specifically designed for warmer climates.

All Season: designed to be used most anywhere a good quality, economy wax is needed. This wax boils out clean, polishes nicely, and is formulated to securely hold teeth.



GROUP/ITEM #	DESCRIPTION	
066-66-013/1LB	Medium Soft size sheets 76mm x 152mm x .060 thick in 1 lb. package.	\$18.20
066-66-014/1LB	Medium Hard size sheets 76mm x 152mm x .060 thick in 1 lb. package.	\$19.34
066-66-012/1LB	All Season size sheets 76mm x 152mm x .060 thick in 1 lb. package.	\$19.76
066-66-016/5LB	Medium Soft size sheets 76mm x 152mm x .060 thick in 5 lb. package.	\$42.47
066-66-017/5LB	Medium Hard size sheets 76mm x 152mm x .060 thick in 5 lb. package.	\$42.47
066-66-015/5LB	All Season size sheets 76mm x 152mm x .060 thick in 5 lb. package.	\$74.18

Justi® Wax Solvent No. 20



An efficient, safe and pleasant scented solvent used for wax elimination and shining after waxing a prosthetic case. An excellent separator for plaster, stone and any other gypsum product. Laboratories have reported to us that they also use Justi Wax Solvent #20 in the following applications:

1. Added to boil tank water.
2. To clean counter tops.
3. To clean tools and equipment.
4. To remove wax from clothing.

GROUP/ITEM #	DESCRIPTION	
070-01-0616	1 Pint	\$21.80
070-01-0632	1 Quart	\$28.31
070-01-0699	1 Gallon	\$71.90

BUY 2 PAY SPECIAL:
\$18.53
\$24.06
\$61.12
EACH



Thermoforming Material

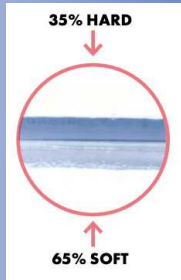

Thermoforming blank made of PETG/EVA, including insulation foil for improved and endured transparency, for the production of:

- occlusion splints for more comfortable wearing characteristics
- hard surface
- soft inner side
- bonds with acrylate clear-transparent — Featured on page 19

GROUP/ITEM #	DESCRIPTION		SPECIAL
031-D420016	Malibu Thermo Hard/Soft 120 x 2 mm	\$66.41	\$63.25
031-D420017	Malibu Thermo Hard/Soft 120 x 3 mm	\$87.73	\$83.56



The Hydrocolloid Alginate

WHILE THE COMPETITION CONTINUES TO TEST...
WE MAKE PERFECT IMPRESSIONS!!

HIGH PRECISION ALGINATE FOR IMPRESSIONS WITH CHROMATIC PHASE INDICATOR

120 HOURS PLUS CASTING

Thirty years ago we were the first to introduce a chromatic alginate to the United States, and now in our European facility, we are manufacturing an alginate designed for dentures, crowns, bridges and orthodontics, with these unique features:

Dimensional Stability—more than 120 hours (after washing, rinsing and removing excess water by shaking, impression must be placed in a Ziploc® bag.)

Pleasant Scent—Patients like the pleasant vanilla scent, which has a neutral taste.

Chromatic Phases:

- Violet (mixing—approx. 35 sec.)
- Rose (packing/working—approx. 40 sec.)
- Light Blue (setting—approx. 45 sec.)

The impression is complete in just about 2 minutes.

- Final impression is light blue for easy reading
- Lead and cadmium free
- Very low dust
- Bio-compatible
- Meets ISO 1563 and ADA #18
- Easy removal—high tear strength
- Four-pound package includes: 4 1 lb bags and 2 measuring cups
- 6-year freshness date
- Antimicrobial

CHROMATIC PHASES
MIXING 35 Seconds
WORKING/PACKING 40 Seconds
SETTING 45 Seconds

GROUP/ITEM #DESCRIPTION
003-2802/4 Alginmax Box of 4 - 1 lb Bags

\$73.31





ALGINPLUS

Extra-high precision alginate for impressions with chromatic phase indicator. New enriched formula for enhanced detail reproduction.

- Stabilized hypoallergenic formula
- Chromatic indication of the working phases for easy and precise results, regardless of water temperature and hardness
- Dust-free powder for safe working and cleaning ease
- Fast wetting time to obtain smooth and plastic consistency for easy mixing
- Excellent gypsum compatibility
- Very high compressive strength and recovery from deformation, exceeding ISO requirements
- Scent: tropical fruit
- Final color: yellow
- Shelf life: 6 years
- Snap setting
- Cadmium and lead free
- Excellent biocompatibility
- High flow and easy mixing
- Package: 453 g (1 lb)

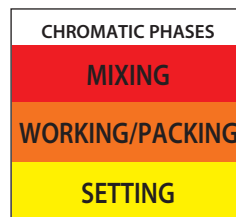

GROUP/ITEM #DESCRIPTION
003-A6004 Alginplus Box of 4 - 1 lb Bags



\$81.87

Pozzi Super-Flexible Mixing Bowls

Their soft, flexible texture and sturdy construction make these bowls indispensable for mixing plaster or alginate. They easily conform to the hand and make mixing a smooth and quick process. These self cleaning plasticized polyvinyl bowls are available in four convenient sizes from 350ml to the max 2250ml size.



GROUP/ITEM #	DESCRIPTION	
017-5501-10	Flexible mixing bowl small blue	\$8.74
017-5501-12	Flexible mixing bowl regular blue	\$9.40
017-5501-14	Flexible mixing bowl large blue	\$10.58
017-5501-16	Flexible mixing bowl max blue	\$17.86

Pozzi Impression Material Accessories

Laboratory Knives

GROUP/ITEM #	DESCRIPTION	
017-420	Fahnstock Large Waxing Knife - 7"	\$16.32
017-421	Fahnstock Large Waxing Knife - 5 1/4"	\$15.36
017-422	Lessmann Small Waxing Knife - 5 1/4"	\$14.82
017-423	Lessmann Small Waxing Knife - 7"	\$15.80
017-424	Waxing Knife with Large Spoon - 7"	\$12.89
017-425	Waxing Knife with Small Spoon - 7"	\$12.05

**SPECIAL: MIX & MATCH
BUY 3 GET 1 FREE!**



Plaster Knives

High quality and fine craftsmanship set these knives apart.

GROUP/ITEM #	DESCRIPTION	
017-426	Plaster Knife - 3/4"	\$17.16
017-428	Plaster Knife - 1/4"	\$15.81
017-429	Plaster Knife - 1/4"	\$15.81

**SPECIAL: \$10.93 EA.
WHEN YOU BUY 3**

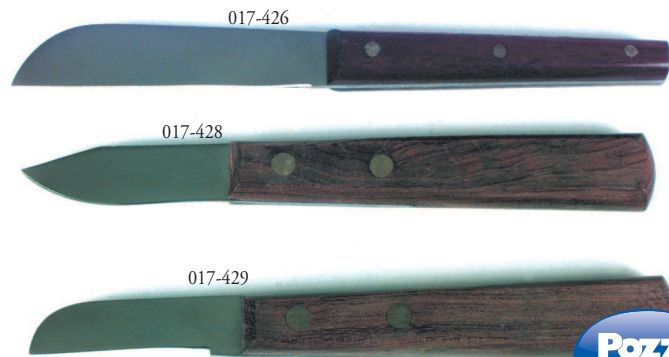

Flask Opening Knife

The dual-purpose flask opening knife is a heavy duty, long lasting instrument made of carbon steel that extends the length of the handle. The butt end has an extrusion designed to open flasks.

GROUP/ITEM #	DESCRIPTION	
017-427	Flask Opening Knife 6 3/4"	\$16.59

SPECIAL: \$10.87 EA.



Pozzi Impression Material Accessories

Nylon Spatulas for Alginates



GROUP/ITEM #	DESCRIPTION	
003-2803/BS	Alginmax Blue Spatula	\$2.09
003-2803/WS	Alginmax White Spatula	\$2.09

SPECIAL: \$1.20 EA.

Stainless Steel Blade Spatulas for Alginate and Plaster

This line of spatulas was designed by dental engineers for better manipulation of alginate and plaster. The curved tips on items 017-434, 017-435 and 017-436 are the most advanced technical design. They help to mix and become a scoop, which is a great help in picking up additional material.



GROUP/ITEM #	DESCRIPTION	
017-430	7¼" Spatula	\$17.94
017-431	7" Spatula	\$17.94
017-432	8¼" Spatula	\$18.57
017-433	8" Flexible Spatula	\$18.57
017-434	7¾" Flexible Spatula	\$17.94
017-435	7¾" Rigid, Heavy Blade Spatula	\$17.94
017-436	8¾" Rigid, Heavy Blade Spatula	\$18.57

SPECIAL: BUY 3 GET 1 FREE!

Disposable Impression Trays

These Pozzi® Impression Trays are made from medical-grade plastic and can be discarded after use, or cold sterilized for repeated use. They are available as single trays in six color-coded sizes, or in kits of 12 and 60 trays. The trays feature multiple retentive grooves and are designed for orthodontic and prosthodontic use. The unique ergonomic handle is user friendly and allows for a firm grip on the tray for easier insertion and removal without slippage.



GROUP/ITEM #	DESCRIPTION	
003-501-060/K	Kit of 60 assorted Duralock Color-Coded Trays, 5 pcs each size	\$47.55

KIT SPECIAL \$40.17

Pozzi Standard Stainless Steel Trays

Perforated stainless steel impression trays—the most popular type. Retention is assured by holes over the whole surface of the tray. A rim on the back edge stops the escape of any material, which is most unpleasant for patients. An anatomical design with rounded comfortable rims especially for adaptation to the oral cavity with respect to frenum, jaw tuberosity and retromolar pads. The dimensions come from research in laboratories throughout the world and are able to cover any anatomical situation. This means more accurate and precise impressions.



GROUP/ITEM #	DESCRIPTION	
003-S2801-12	Stainless Steel Impression Kit, 12 pcs. Kit contains one each: U1, U2, U3, U4, U5, U6, L1, L2, L3, L4, L5, L6	\$193.53

SPECIAL: \$126.79 KIT

Utility Pliers

Stainless Steel Pliers

Our studies have proven that top quality pliers will save money and produce better results. Due to the nature of orthodontic wire bending and the use of heavy wires, it is essential that durable, high-quality

instruments be used. Pozzi stainless steel pliers are the best quality instruments that money can buy! When ordering, please specify item number and size.



Pozzi 3-Jaw Plier

For bending of Rapid Expander Arms, for wires up to 1.5 mm

This is also a great tool for adjusting facebows as the rounded tips protect the wire from scoring.

GROUP/ITEM #	DESCRIPTION
019-AP1034-00	3-Jaw Round Plier (Sand Finish) \$65.00

SPECIAL SALE
\$51.75

Utility Pliers

Pages 28-37

**Buy 3 Pliers or Instruments Same Type
Get 1 FREE SAME TYPE**

Flat Nose Pliers

General utility pliers. Heavy duty.

- | GROUP/ITEM # | DESCRIPTION |
|---------------|---|
| 007-8-601-018 | Flat Nose Pliers 5 1/2" (14 cm), serrated \$97.62 |
| 007-8-601-019 | Flat Nose Pliers 5 1/2" (14 cm), smooth \$94.05 |
| 007-8-601-020 | Flat Nose Pliers 5 1/2" (14 cm), with groove \$93.87 |
| 007-8-601-020 | Flat Nose Pliers 5 1/2" (14 cm), with groove \$93.87 |



Small Flat Nose Pliers

General utility pliers for detail work.

- | GROUP/ITEM # | DESCRIPTION |
|---------------|--|
| 007-8-601-006 | Small Flat Nose Pliers 4 3/4" (12 cm), serrated \$88.08 |
| 007-8-601-007 | Small Flat Nose Pliers 4 3/4" (12 cm), smooth \$83.23 |

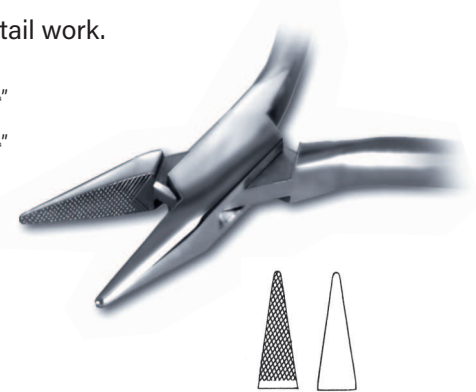

Wide Flat Nose Pliers

General utility pliers with squared beak. Heavy duty.

- | GROUP/ITEM # | DESCRIPTION |
|---------------|---|
| 007-8-601-001 | Wide Flat Nose Pliers 5 1/2" (14 cm), serrated \$92.79 |
| 007-8-601-002 | Wide Flat Nose Pliers 5 1/2" (14 cm), smooth \$93.25 |



Round Nose Pliers

Utility pliers specifically designed with flat-edged tips and round beaks on both sides.

- | GROUP/ITEM # | DESCRIPTION |
|---------------|--|
| 007-8-601-022 | Round Nose Pliers 5 1/2" (14 cm), small tip \$90.89 |



Round Nose Pliers

Same pliers as 007-8-601-022 with larger beaks.

- | GROUP/ITEM # | DESCRIPTION |
|---------------|--|
| 007-8-601-023 | Round Nose Pliers 5 1/2" (14 cm), large tip \$92.80 |



Peeso

Band and crown stretching plus contouring pliers.

- | GROUP/ITEM # | DESCRIPTION |
|---------------|----------------------------------|
| 007-8-601-051 | Peeso 6" (15 cm) \$121.59 |

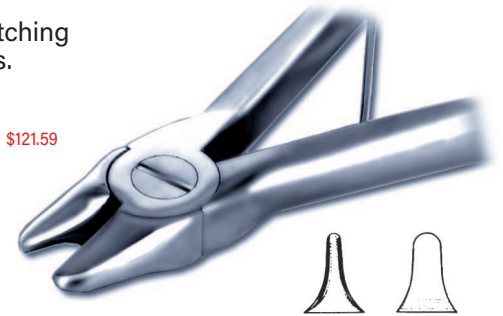

Triplex

Combining three of the most popular contouring pliers: Johnson, Reynolds and Waldron.

- | GROUP/ITEM # | DESCRIPTION |
|---------------|--|
| 007-8-601-038 | Triplex 5 1/2" (14 cm) \$163.24 |



Special Inox Plaster Nippers

Stainless steel nippers especially handy for accurate chipping of excess plaster from laboratory work models. Cuts plaster and stone.

- | GROUP/ITEM # | DESCRIPTION |
|--------------|---|
| 007-444 | Special Inox Plaster Nippers \$70.85 |



THE QUICK DESTROYER

**SPECIAL SALE
\$48.30**

Utility Pliers

Reynolds

Curved shortened beaks. Used in band forming and contouring.

GROUP/ITEM #	DESCRIPTION
007-8-601-033	Reynolds 5" (13 cm) \$98.54

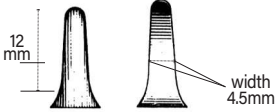

Benson

Larger beaks than the Peeso. Used for band and crown stretching plus contouring.

GROUP/ITEM #	DESCRIPTION
007-8-601-052	Benson 6" (15 cm) \$125.11

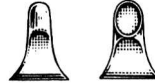

Gordon

Curved elongated beaks. Used in band forming and contouring.

GROUP/ITEM #	DESCRIPTION
007-8-601-035	Gordon 5" (13 cm) \$92.77

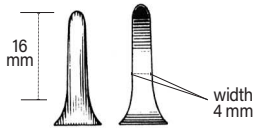

Weingart

Precision ground tips assure a firm positive grip. The narrow beaks at the tip allow accessibility to all areas.

GROUP/ITEM #	DESCRIPTION
007-8-602-000	Weingart 6" (15 cm) \$109.24

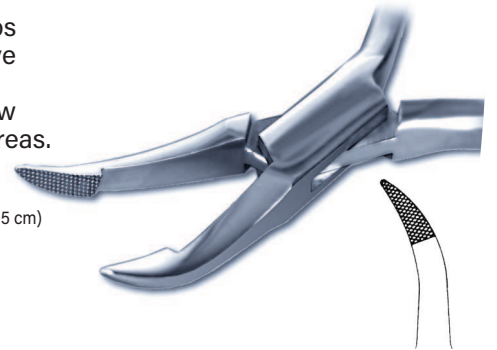

How

Precision-serrated tips assure a firm, positive grip during use.

GROUP/ITEM #	DESCRIPTION
007-8-602-005	How 5 3/4" (14.5 cm), straight \$91.22
007-8-602-006	How 5 1/2" (14.0 cm), curved \$109.66

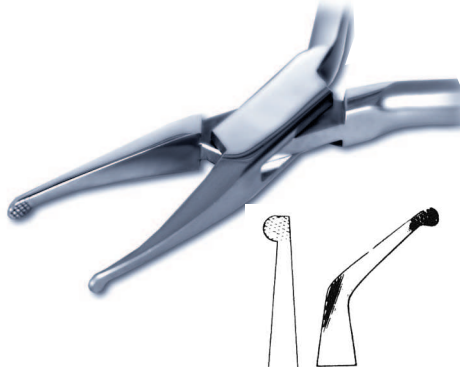

Mathieu Hemostat Forcep Needle Holders

Positive locking ratchet allows instant opening and closing. Used by many orthodontists for twisting or tying ligature wire.

GROUP/ITEM #	DESCRIPTION
007-8-605-914	Mathieu Needle Holder 5 1/2" (14 cm), standard \$126.71
007-8-605-915	Mathieu Needle Holder 5 1/2" (14 cm), narrow \$127.56



Broken Broaches Removing Pliers

Elongated and tapered tips for removing elastics from inaccessible areas.

GROUP/ITEM #	DESCRIPTION
007-8-601-101	Broken Broaches Removing Pliers 5 1/2" (14 cm), curved \$117.65

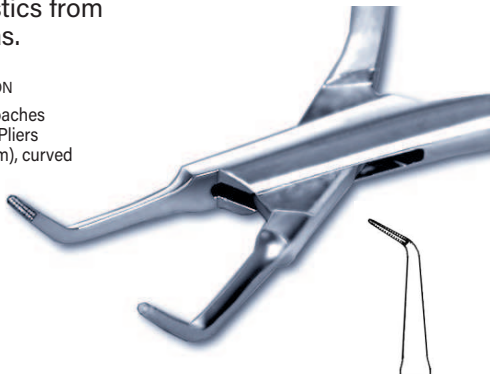

Anterior Band Removing Pliers

Designed for the removal of anterior bands. Prevents danger of stretching or deforming the band. Comfortable for the patient without marring teeth.

GROUP/ITEM #	DESCRIPTION
007-8-602-535	Anterior Band Removing Pliers 5" (13 cm) \$90.59

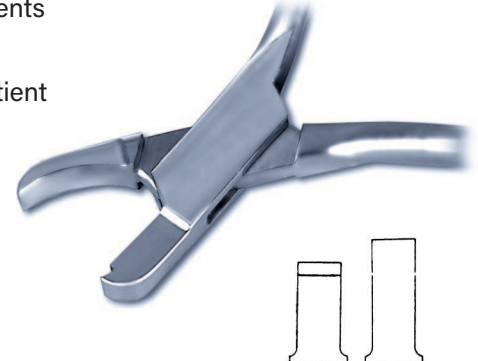

Utility Pliers

Posterior Band Removing Pliers

Extended jaw design allows the removal of posterior bands from inaccessible areas. Plastic tips are optional.

GROUP/ITEM # DESCRIPTION
007-8-602-536 Posterior Band Removing Pliers 5 1/2" (13.5 cm)
\$122.16

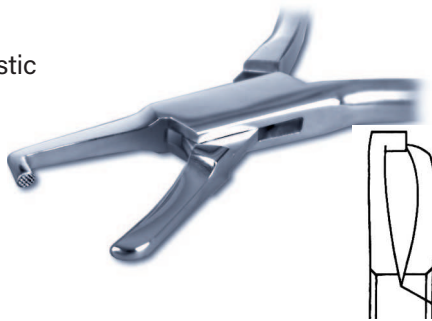

Johnson

Crimping and contouring pliers for bands, crowns and general use.

GROUP/ITEM # DESCRIPTION
007-8-601-028 Johnson 5 1/2" (14 cm)
\$95.78



Nance/Adams Clasp Pliers

Allows the technician to produce a nance or adams clasp quickly and efficiently.

GROUP/ITEM # DESCRIPTION
007-8-601-034 Nance/Adams Clasp Pliers
\$151.33



Anterior Direct Bond Bracket Remover

Wedging the tips under the bracket brace, allows for easy and efficient removal. Firm grip assures ease in horizontal use.

GROUP/ITEM # DESCRIPTION
007-8-601-074 Anterior Direct Bond Bracket Remover
\$114.16



Hemostat / Forcep Mosquito Tip Straight

Modules sit securely in the tip. Hemostat prevents crushing of the ligature.

GROUP/ITEM # DESCRIPTION
007-8-605-005 Hemostat / Forcep Mosquito Tip Straight
\$148.20



Hemostat / Forcep Mosquito Tip Curved

Provides easy access to posterior regions.

GROUP/ITEM # DESCRIPTION
007-8-630-8014 Hemostat / Forcep Mosquito Tip Curved
\$137.21



Hemostat / Forcep Mosquito Hook Tip

Hemostat has a recessed holding hook that prevents tearing of either the ligature or elastic.

GROUP/ITEM # DESCRIPTION
007-8-605-004 Hemostat / Forcep Mosquito Hook Tip
\$154.29



Rose Torquing Pliers

Rose Torquing Pliers wide with key .018 x .022. Designed to place torque in a specific section of archwire (single tooth) without distorting the remainder of the wire. The key is designed to torque the section between holding beaks - the torqued section will not extend past the contact points of the pliers beaks and will engage easily without transfer of torque to adjacent teeth. Labial torque and lingual torque can be placed next to each other with ease. Works with all arch wires.

GROUP/ITEM # DESCRIPTION
007-OM-805W Rose Torquing Pliers Wide with key
\$126.79



Pozzi Wire Benders

Andresen

Use for precise bending and making loops for light wires.

GROUP/ITEM # DESCRIPTION
007-8-601-060 Andresen 5 1/2" (14 cm)
\$105.67



Adams

Squared tips. The jaws are parallel at 1 mm opening.

GROUP/ITEM # DESCRIPTION
007-8-601-043 Adams 5" (13 cm)
\$93.36

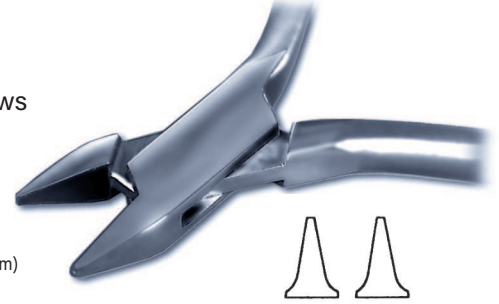

Angle Tweed Rectangular Arch Forming Pliers

Arch bending and torquing pliers. Non-slip parallel holding action on rectangular wire up to .025" x .208".

GROUP/ITEM # DESCRIPTION
007-8-601-076 Angle Tweed Rectangular Arch Forming Pliers 5" (13 cm)
\$91.48



Wire & Clasp Bending Pliers

Elongated beaks for precise bending of light wires and clasps.

GROUP/ITEM # DESCRIPTION
007-8-601-079 Wire and Clasp Bending Pliers 5 1/2" (14 cm)
\$102.40

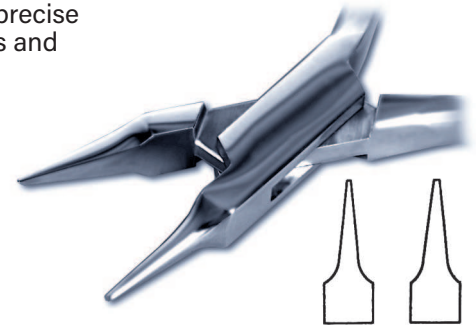

Young

Wire bending pliers with 4-step beak.

GROUP/ITEM # DESCRIPTION
007-8-601-064 Young 5" (13 cm)
\$136.61

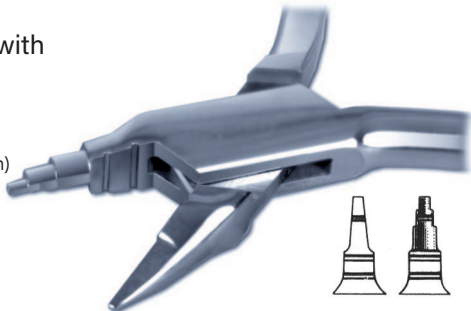

Tweed Loop

Has narrow concave beak on one side with three step on the other side for use on round or edgewise wire up to .020".

GROUP/ITEM # DESCRIPTION
007-8-601-070 Tweed Loop 5 1/2" (14 cm)
\$106.41



Aderer Three Pronged Pliers

Use for opening, closing and adjusting clasps.

GROUP/ITEM # DESCRIPTION
007-8-601-040 Aderer Three Pronged 4 3/4" (12 cm)
\$108.55

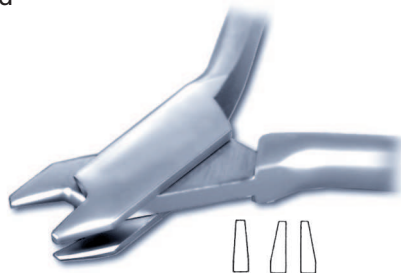

Aderer

Same pliers as 007-8-601-040 with smaller and shorter tips.

GROUP/ITEM # DESCRIPTION
007-8-601-048 Aderer Three Pronged 4 1/2" (11.5 cm)
\$94.99



Pozzi 3-Jaw Plier

For bending of Rapid Expander Arms, for wires up to 1.5 mm.

GROUP/ITEM # DESCRIPTION
019-AP1034-00 3-Jaw Round Plier (Sand Finish) **\$65.00**



Pozzi Wire Benders

Aderer

Arch bending pliers. Two types - 2 groove and 3 groove.

GROUP/ITEM #	DESCRIPTION
007-8-601-012	Aderer 53/4" (14.5 cm) 3 grooves \$98.49
007-8-601-024	Aderer 51/2" (14 cm) 2 grooves \$99.02

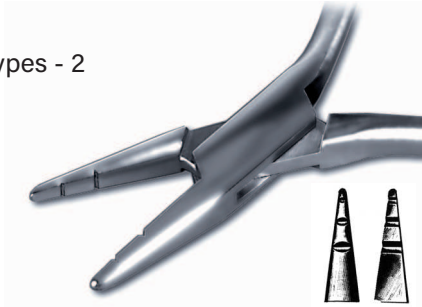

Waldron

Arch and spring bending pliers.

GROUP/ITEM #	DESCRIPTION
007-8-601-030	Waldron 5" (13 cm) \$93.43

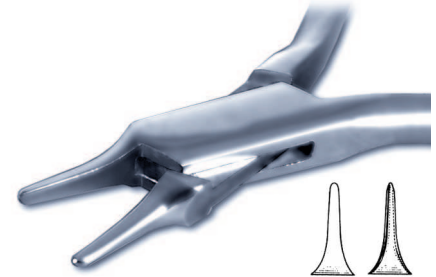

Aderer Lingual Bar Heavy Face Bow

Three-pronged box joint pliers designed for the heavy bending of lingual bars, face bows and clasps. Heavy duty.

GROUP/ITEM #	DESCRIPTION
007-8-601-041	Aderer Lingual Bar (Heavy Face Bow) \$101.33



Jarabak

For precise bending of light wires. The three grooves ensure accurate bending and closing of loops.

GROUP/ITEM #	DESCRIPTION
007-8-601-063	Jarabak 51/2" (14 cm) \$101.95

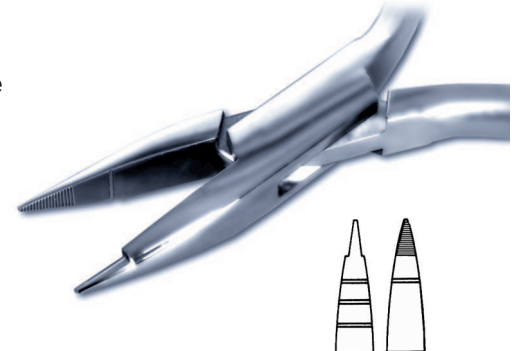

Bird Beak Pliers

Both round and flat beaks permit the bending of rectangular and round wire up to .030"

GROUP/ITEM #	DESCRIPTION
007-8-601-077	Bird Beak 5" (13 cm) \$111.73

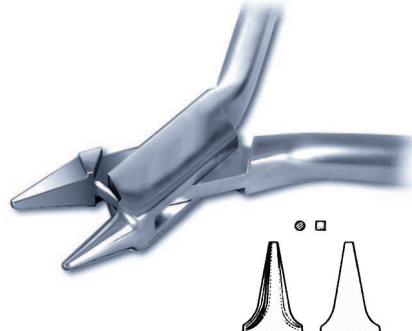

Hollow Chop

For contouring round arch wires. Smooth beaks.

GROUP/ITEM #	DESCRIPTION
007-8-601-069	Hollow Chop 51/2" (14 cm) \$97.39

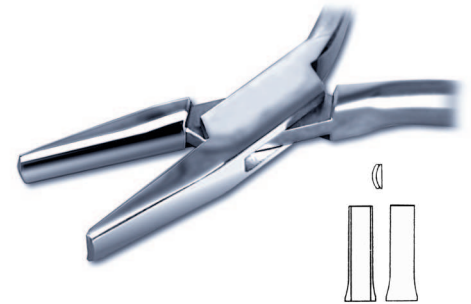

Lite Wire

Pliers designed for forming and bending up to .020" wire. Also for making and closing loops.

GROUP/ITEM #	DESCRIPTION
007-8-601-078	Lite Wire 5" (13 cm) \$105.05



Optical Pliers

Precision concave beaks for clasp and wire bending. Can be used on both round and edgewise wire to bend to exacting measurements.

GROUP/ITEM #	DESCRIPTION
007-8-601-071	Optical 43/4" (13 cm) \$91.36

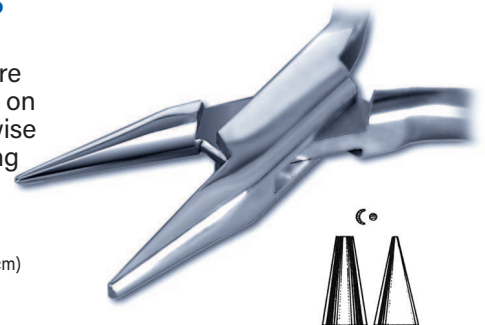

Schwarz

Light wire, small optical pliers with concave beaks.

GROUP/ITEM #	DESCRIPTION
007-8-601-067	Schwarz 5" (13 cm) \$93.51



Wire Bending Pliers

Precision round and concave beaks for clasp and wire bending. Can be used on both round and edgewise wire up to .040.

GROUP/ITEM #	DESCRIPTION
007-440	Wire Bending Pliers \$134.41



Pozzi Wire Benders & Cutters

Clasp Bending Pliers

GROUP/ITEM # DESCRIPTION
007-442 Clasp Bending Pliers
\$136.34



Heavy Duty Waldsachs

General forming and bending pliers. Heavy duty.

GROUP/ITEM NO. DESCRIPTION
007-443 Cutting Pliers, Waldsachs
\$139.21



Heavy Duty Wire & Plate Scissors

GROUP/ITEM # DESCRIPTION
017-437 Heavy Duty Wire and Plate Scissors
\$83.19



Scissors And Cutters

Universal collar and crown scissors. For cutting bands and soft wire.

GROUP/ITEM # DESCRIPTION
007-8-604-046 Crown Scissors, Smooth Edge 43/4" (12 cm), Straight
\$89.52
007-8-604-047 Crown Scissors, Smooth Edge 43/4" (12 cm), Curved
\$97.39



007-8-604-046

Lab Cutting Pliers

Designed to cut lab wires up to 0.040"

GROUP/ITEM # DESCRIPTION
007-8-603-091H Lab Cutting Pliers
\$309.36



Pin & Ligature Wire Cutter

Special carbide steel blades assure accurate, dependable cutting edges. Perfect for cutting lock and key pins. Stainless steel. Cuts soft wire up to .010". Do not use on hard wire.

GROUP/ITEM # DESCRIPTION
013-19790 Pin and Ligature Wire Cutter
\$137.95



Wire Cutting Pliers

Designed to cut lab wire up to 0.040"

GROUP/ITEM # DESCRIPTION
007-8-603-092 Wire Cutting Pliers
\$110.23



Hemostat/Forcep Mosquito Hook tip

Hemostat has a recessed holding hook that prevents tearing of either the ligature or elastic.

GROUP/ITEM # DESCRIPTION
007-8-605-004 Hemostat / Forcep Mosquito Hook Tip
\$154.28



Ligature Wire Cutter

Designed to clip metal ligatures.

GROUP/ITEM # DESCRIPTION
007-8-603-093 Ligature Wire Cutter
\$107.50



Heavy Duty Lab Pliers

Designed to cut lab wire up to 0.032"

GROUP/ITEM # DESCRIPTION
007-8-603-096 Heavy Duty Lab Pliers
\$135.94



We wanted to manufacture a pliers like the ones you used to be able to buy in the old days - without having to mortgage the farm!

We feel that once you use one of these pliers you will know why it is a real classic!

All of the "Classika" instruments are made of corrosion resistant stainless steel. All "Classika" cutting instruments have tool steel inserts. All "Classika" cutting instruments have diamond-honed cutting edges and have a hard chrome finish. They withstand all accepted methods of sterilization.

All "Classika" instruments have a balanced assembly wobble-free sliding lock joint. No more shim joints to deal with. All come with extended "sure grip" handles and are guaranteed to be free from manufacturing defects. Any instrument that proves defective in workmanship and materials will be repaired or replaced at our discretion free of charge. All instruments carry a two year warranty.

Black Hard Wire Cutter

Specially designed for cutting hard wires. The cutting angle is 15 degrees and the cutting edges have been diamond-honed to allow hard wire cutting. Maximum cutting capacity is .20 diameter in hard wire.

GROUP/ITEM #	DESCRIPTION
040-40-0015	Black hard wire cutter \$181.19



Flush Cut Distal End Cutter with Safety Hold

The particular design of this cutter allows distal end arch wires to be cut in the patient's mouth safely. It cuts wire and then "safety holds" the loose wires.

Maximum cutting capacity: rectangular wire up to .022x.028" (0,56x0,71mm); round wire up to .020" (0,51mm); twist wire up to .016" (0,41mm) in diameter.

GROUP/ITEM #	DESCRIPTION
040-40-0017R	Distal end cutter \$181.19



Miniature Pin & Ligature Cutter

This standard pin cutter is non-angled and designed to cut soft wires. This pliers is very popular for chairside work. Maximum cutting capacity is .015 in soft wire.

GROUP/ITEM #	DESCRIPTION
040-40-0016	Miniature pin and ligature cutter \$181.19



Micro-Miniature Light Wire Cutter with Stop Screw

This pliers is designed as a miniature ligature cutter that will cut soft wire. It easily reaches those hard-to-reach areas in the mouth. It has a factory adjusted stop screw that prevents tip damage due to overscrewing the cutter during routine procedures. Maximum cutting capacity is soft wire up to .012 in diameter.

GROUP/ITEM #	DESCRIPTION
040-40-0018	Micro-Miniature cutter \$181.19



15° Pin & Fine Wire Cutter

The tip is angled 15 degrees for better field vision. The tooled steel inserted tips have backing ledges for greater strength. Maximum cutting capacity is .015 diameter for both soft and hard wire.

GROUP/ITEM #	DESCRIPTION
040-40-0014	15 degree pin and fine wire cutter \$181.19



Pozzi Tube Crimping Pliers

Stainless Steel Crown Cutting Tools

Small Straight Scissors

Use for trimming anterior crowns.

GROUP/ITEM #
040-40-0028
\$140.28



Tube Crimping Pliers

Used to crimp the tube around a space maintainer wire. It can also be used for placing stops and tubing on arch wires.

GROUP/ITEM #
040-40-0033

DESCRIPTION
Tube Crimping Pliers
\$246.93

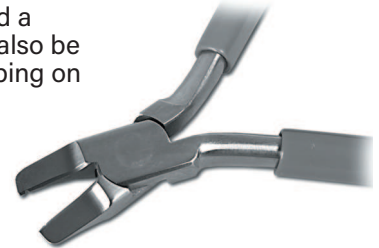

Stainless Steel Crown Pliers

Small Crown Crimping Pliers

This tool is handy for anterior crowns and smaller sizes in the primary molars.

GROUP/ITEM #
040-40-0031
\$246.93



Regular Crown Crimping Pliers

This is the standard in the industry for all posterior crowns.

GROUP/ITEM #
040-40-0030
\$246.93



Crown Contouring Pliers

For adding contour to the crown for a better fit.

GROUP/ITEM #
040-40-0032
\$246.93



Mini-Distal End Cutter

Smaller than standard. Cuts and holds in one operation.

GROUP/ITEM #	DESCRIPTION
007-8-603-090H	Mini-Distal End Cutter \$239.68



Posterior Direct Bond Bracket Remover

Direction provides easy access to confined posterior areas. Easy vertical removal.

GROUP/ITEM #	DESCRIPTION
007-8-601-075	Posterior Direct Bond Bracket Remover \$145.80



Pozzi Line Additions

Boynton-style Elastomeric Pliers

Features a smaller head with narrower arms for easier access to the posterior. An ideal alternative multiple use tool for the Crown & Bridge and Ceramics department.

GROUP/ITEM #
007-8-028-125
\$165.80

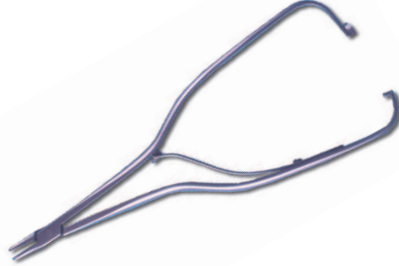

Mathieu Needle Holder

Positive locking ratchet allows instant opening and closing. Used by many orthodontists for twisting or tying ligature wire. An excellent general use instrument for Crown & Bridge and Ceramic technicians worldwide.

GROUP/ITEM #
007-8-605-915O
\$127.56



V-Stop Bend Pliers

Forms a 1 mm high V bend automatically. Used to shorten arch wires or to place a strategic stop in the arch wire, such as the midline, which avoids any unwarranted displacement of the archwire. Used by laboratories for wrought wire modifications in transitional partials.

For wires up to .025"

GROUP/ITEM #
007-8-601-045
\$121.36



Prolong Flat Nose Pliers

Serrated

Similar to a standard Mathieu except the tips are ultra fine to facilitate application of elastomeric ligature ties.

GROUP/ITEM #
007-8-605-125
\$129.52

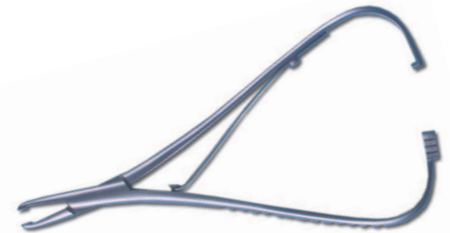

Side Cutter Pliers - Heavy Duty

Heavy duty pliers designed to cut wire up to .040"

GROUP/ITEM #
007-8-603-096H
\$221.96



Mathieu Needle Holder

Short Beak

General detail serrated utility pliers for detail work 6" - 15cm

GROUP/ITEM #
007-8-601-015
\$88.60



Side Cutter Pliers

Will cut up to .020" round wire. Features dual reciprocal springs for a lighter touch and less hand fatigue.

GROUP/ITEM #
007-8-603-098H
\$112.55



Pozzi Special Guarantee

Pozzi pliers and instruments are guaranteed for a period of two years from date of purchase to be free from defects in workmanship and/or materials. Any product that proves defective in workmanship and materials will be repaired or replaced, at our discretion, free of charge.

NEW PRODUCTS

Line of Expanders

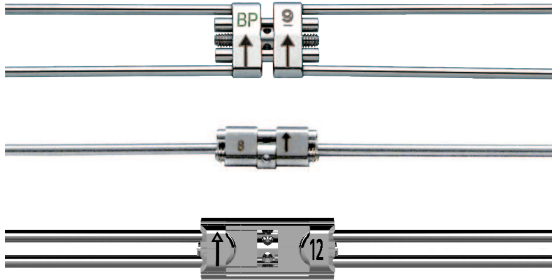

SEE PAGE 2-7

NEW PRODUCTS

Thermoforming Material



SEE PAGE 23

PLIERS

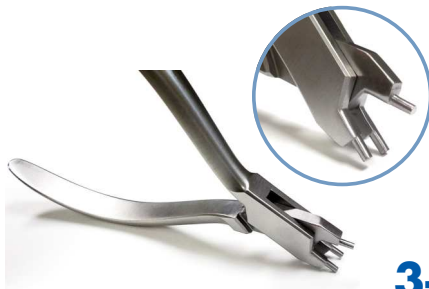

3-Jaw Round Plier

SEE PAGE 28-37

ORTHO MATERIALS

POZZI ORTHO RESIN



SEE PAGE 16

ORTHO COLORS & GUIDES



SEE PAGE 16-17

ALGINPLUS



SEE PAGE 25

ORTHO ACCESSORIES

BANDS



SEE PAGE 9

SOLDER

SILVER SOLDER + WHITE FLUX



SEE PAGE 13

Where to find us



American Tooth Industries
1200 Stellar Drive
Oxnard, California 93033-2404
info@americantooth.com
pozziorthodontics.com

Buy Online:
americantooth.com/store

CALL TODAY TO PLACE YOUR ORDER
805-487-9868

ACCEPTED!

